

**CURTISS -
WRIGHT**



PG DRIVES TECHNOLOGY

VR2 - TECHNICAL MANUAL

SK77898/5



© Curtiss-Wright 2014

All rights reserved.

This manual is furnished under copyright and may only be used in accordance with the terms laid out by Curtiss-Wright.

The information in this manual is furnished for informational use only, is subject to change without notice, and should not be construed as a commitment by Curtiss-Wright.

Except as permitted by such terms, no part of this manual may be reproduced, stored in a retrieval system, or transmitted, in any form or by any means electronic, mechanical, recording, or otherwise - without the prior written permission of Curtiss-Wright. +44.1425.271444



TABLE OF CONTENTS

CHAPTER 1 - OPERATION 9

1 INTRODUCTION 9

2 General 9

2.1 Handling9

2.2 Operating Conditions9

2.3 Cleaning9

3 Controls 10

3.1 On/Off Button and Battery Gauge11

3.2 Locking / Unlocking the Wheelchair11

3.3 Joystick11

3.4 Maximum Speed / Profile Indicator12

3.5 Horn Button12

3.6 Speed / Profile Decrease Button12

3.7 Speed / Profile Increase Button12

3.8 Actuator Buttons and LEDs12

3.9 Charger and Programmer Socket13

4 Getting Ready to Drive 14

5 Tips for Using Your Control System 14

5.1 Driving - General14

5.2 Driving Technique14

6 Precautions for Use 15

6.1 Hazards15

7 Safety Checks 16

7.1 Daily Checks16

7.2 Weekly Checks16

7.3 Servicing16

8 Control System Status indication 17

8.1 Battery Gauge is Steady17

8.2 Battery Gauge Flashes Slowly17

8.3 Battery Gauge Steps Up17

8.4 Battery Gauge Flashes Rapidly (even with the joystick released)17

8.6 Slow or sluggish movement19

8.7 Speed / Profile Indicator is Steady19

8.8 Speed / Profile Indicator Ripples Up and Down 19

8.9 Speed / Profile Indicator Flashes 19

8.10 Actuator LED Flashes 20

9 Battery Gauge20

9.1 How to Read a TruCharge Battery Gauge 20

10 Battery Charging21

11 Programming21

12 Joystick Knobs22

13 Servicing22

14 Warranty22

CHAPTER 2 - INSTALLATION 25

1 Documentation25

1.1 VR2 Operation 25

1.2 Program Settings 25

1.3 Soft-Stop 26

1.4 Other Information 26

1.5 Control System Make-up 26

2 Immobilizing the Wheelchair27

2.1 Prevention of Unauthorized Use 27

2.2 Charger Interlock 27

3 Mounting27

3.1 Joystick Module 27

3.2 Power Module Mounting 28

4 Connections29

4.1 Crimping 30

4.2 Connector Kits 30

5 Wiring31

5.1 General 31

5.2 Wire Gauge and Types 31

5.3 Battery Wiring 32

5.4 Motor Wiring 32

5.5 Solenoid Brake Wiring 32



- 6 Drive Motors33
- 7 Batteries34
- 8 Battery Charging34
 - 8.1 Off-board Charging34
 - 8.2 On-board Charging35
- 9 Inhibits35
- 10 Actuator Control35
 - 10.1 Actuator End-stop Detection36
 - 10.2 Actuator Inhibits36
 - 10.3 Actuator Motors36
- 11 Production Tests37
 - 11.1 Mounting37
 - 11.2 Cables and Connectors37
 - 11.3 Joystick and Gaiter37
 - 11.4 Preset Settings37
 - 11.5 Operational Test37
 - 11.6 Test Drive38
 - 11.7 Soft-Stop Test38
- 12 Electromagnetic Compatibility (E.M.C.)38
 - 12.1 Emissions38
 - 12.2 Immunity39
- 13 Battery Gauge39

CHAPTER 3 – NVR241

- 1 INTRODUCTION41
- 2 Controls42
 - 2.1 Control System Status Indication42
 - 2.1.2 First LED flashing slowly43
 - 2.2 Battery Gauge44
- 3 Mounting and Installation45
 - 3.1 Joystick Module mounting45
 - 3.2 Power Module mounting45
- 4 Power Module Wiring46
 - 4.1 General46
 - 4.2 Power Module Wiring46
 - 4.3 Wire gauges47

- 4.4 Battery Wiring 47
- 4.5 Solenoid Brakes 48
- 4.6 Battery Charging 48

CHAPTER 4 - PROGRAMMING49

- 1 INTRODUCTION49
 - 1.1 Hand-held Programmers 49
 - 1.2 PC Programmer 49
 - 1.3 Parameters 50
 - 1.4 Safety Fences 51
 - 1.5 Drive Profiles 51
- 2 Speed Parameters52
 - 2.1 Acceleration 52
 - 2.2 Deceleration 52
 - 2.3 Turn Acceleration 52
 - 2.4 Turn Deceleration 52
 - 2.5 Forward Speed 52
 - 2.6 Reverse Speed 53
 - 2.7 Turning Speed 53
 - 2.8 Power 53
 - 2.9 Number of Drive Profiles 53
 - 2.10 Minimum Acceleration 54
 - 2.11 Minimum Deceleration 54
 - 2.12 Minimum Turn Acceleration 54
 - 2.13 Minimum Turn Deceleration 55
- 3 Actuator Parameters55
 - 3.1 Number of Actuators 55
 - 3.2 Actuator 1 End Force 55
 - 3.3 Actuator 1 Current Limit Time Out 55
 - 3.4 Actuator 2 End Force 56
 - 3.5 Actuator 2 Current Limit Time Out 56
 - 3.6 Actuator Selection with Joystick 56
 - 3.7 Actuator End Stop Detection 56
 - 3.8 Actuator End Stop Bleep 56
 - 3.9 Invert Actuator Axis 1 57
 - 3.10 Invert Actuator Axis 2 57
- 4 Operation Parameters57
 - 4.1 Sleep Timer 57
 - 4.2 Joystick Throw 57
 - 4.3 Invert Joystick 58
 - 4.4 Steer Correct 58
 - 4.5 Switch Bleep Volume 58



4.6	Speed Adjustment while Driving	58	7.13	Front Wheel Drive Rate	70
4.7	Service Timer	59	7.14	FWD Acceleration Limit	71
5	Battery Parameters	59	7.15	Advanced Electronic Stability (AES)	71
5.1	Low Battery Flash Level	59	7.16	AES Rate	71
5.2	Cable Resistance	59	8	Motor Parameters.....	72
5.3	Calibration Factor	60	8.1	Current Limit Max., Current Limit Min., Current Foldback - Threshold, Time, Level, & Temperature Boost Current & Time	72
5.4	Low Battery Alarm	60	8.2	Motor Compensation.....	75
5.5	Low Voltage Cut Out.....	60	8.3	Invert M1 Direction.....	76
5.6	Low Voltage Time	60	8.4	Invert M2 Direction.....	76
6	Inhibit Parameters.....	60	8.5	Motor Swap	76
6.1	Inhibit 2 Threshold Level	61	8.6	Torque.....	76
6.2	Inhibit 2 Speed Limit in Band x	61	8.7	Tremor Damping	77
6.3	Inhibit 2 Operation	62	8.8	Joystick Stationary Time	77
6.4	Inhibit 2 Debounce	62	8.9	Joystick Stationary Range	77
6.5	Seat Reversal	62	8.10	Demand Clipping (R-net).....	77
6.6	Inhibit 3 Threshold Level	62	8.11	Turning Torque	78
6.7	Inhibit 3 Speed Limit in Band x	63	8.12	Motor Stall Timeout.....	78
6.8	Inhibit 3 Operation	63	9	Memory Functions	79
6.9	Inhibit 3 Debounce	63	9.1	Read Timer	79
6.10	Inhibit 1: Alarm.....	64	9.2	Clear Timer.....	79
6.11	Inhibit 2: Alarm.....	64	9.3	Read System Log	79
6.12	Inhibit 3: Alarm.....	64	9.4	Erase System Log	79
6.13	Actuator Channel 1 Up Inhibit and Actuator Channel 1 Down Inhibit	64	9.5	Service Log	79
6.14	Actuator Channel 2 Up Inhibit and Actuator Channel 2 Down Inhibit	65	CHAPTER 5 – LIGHTING MODULE.....	81	
6.15	Inhibit Examples	65	1	Introduction	81
6.16	Disable Inhibit 2 in Drive.....	67	2	Controls.....	81
6.17	Disable Inhibit 3 in Drive.....	68	2.1	Actuator Button and LEDs.....	81
7	General Parameters	68	2.2	Light Button Indicator	82
7.1	Fast Brake Rate.....	68	2.3	Left Turn Indicator Button and LED	83
7.2	Soft Stop Rate.....	68	2.4	Right Turn Indicator Button and LED	83
7.3	Soft Reverse Deceleration	68	2.5	Hazard Warning Button and LED	83
7.4	Soft Reverse Deceleration	69	3	Lighting Module Installation	83
7.5	Reverse Driving Alarm	69	3.1	Mounting	83
7.6	Brake Disconnected Alarm	69	3.2	Connection.....	84
7.7	K10 Programming Restriction.....	69	3.3	Output.....	84
7.8	Lock Function Enabled.....	69	3.4	Wiring.....	85
7.9	Brake Fault Detect	70	4	Programming.....	86
7.10	Brake Voltage	70			
7.11	Output Voltage	70			
7.12	Front Wheel Drive Type.....	70			



- 4.1 Lamp Voltage.....86
- 4.2 Lamp Wattage87
- 4.3 Indicator Fault Detect.....87

CHAPTER 6 – ATTENDANT MODULE89

- 1 Introduction89
- 2. Controls.....90
 - 2.1 Joystick90
 - 2.2 Control Button and Indicator90
 - 2.3 Actuator Button and LEDs90
 - 2.3.1 Wheelchairs with One Actuator90
 - 2.4 Maximum Speed Button and Indicator91

- 3 Installation91
- 4 Connection.....92

- 4.1 Connection to the VR2 Attendant module.....92
- 4.2 VR2 Attendant Module & Lighting Module93

- 5 Joystick Orientation94

CHAPTER 7 – SERVICING & DIAGNOSTICS95

- 1 Servicing.....95
 - 1.1 Introduction.....95
 - 1.2 Joystick Replacement (VR2)96
 - 1.3 Joystick Replacement (nVR2)98
 - 1.4 Joystick Cable Replacement101
 - 1.5 Keypad Replacement.....103

- 2 Diagnostics104
 - 2.1 Introduction.....104
 - 2.2 Diagnostics Process104
 - 2.3 Detecting a Trip has Occurred104
 - 2.4 Other Conditions105
 - 2.5 Trip Diagnosis106

3 Trip Types and Their Possible Causes107

- 3.1 Trip Type 1 - Low Battery Voltage108
- 3.2 Trip Type 2 – Left Motor Disconnected108
- 3.3 Trip Type 3 – Left Motor Wiring Trip108
- 3.4 Trip Type 4 – Right Motor Disconnected109
- 3.5 Trip Type 5 - Right Motor Wiring Trip109
- 3.6 Trip Type 6 – Charger Connected109
- 3.7 Trip Type 7 – Possible Joystick Trip109

- 3.8 Trip Type 8 - Possible Control System Trip 110
- 3.9 Trip Type 9 - Solenoid Brake Trip 110
- 3.10 Trip Type 10 - High Battery Voltage 110
- 3.11 Joystick Displaced at Power-up..... 111
- 3.12 Communications Error 111
- 3.13 Inhibit 2 Active 111
- 3.14 Inhibit 3 Active 111
- 3.15 Actuator Motor Wiring Trip 111
- 3.16 Timed Foldback Active 112
- 3.17 Thermal Foldback Active..... 112
- 3.18 Controller in Sleep Mode 112
- 3.19 Attendant Module Trip 112

4 Basic Tests..... 113

- 4.1 General Inspection..... 113
- 4.2 Brake Test 113
- 4.3 Drive Test..... 113

4.4 Gradient Test 114

5 Servicing of Defective Units..... 114

CHAPTER 8 – WARNING SUMMARY 115

- 1 Introduction 115
- 2 Warnings..... 115

- 2.1 Driving Technique 115
- 2.2 Hazards 115
- 2.3 How to Read a TruCharge Battery Gauge 116
- 2.4 Battery Charging 116
- 2.5 Programming 116
- 2.6 Joystick Knobs..... 117
- 2.7 Servicing..... 117
- 2.8 Warranty..... 117
- 2.9 Program Settings..... 117
- 2.10 Charger Interlock 117
- 2.11 Position 117
- 2.12 Crimping..... 118
- 2.13 Wiring – General 118
- 2.14 Battery Wiring..... 118
- 2.15 Drive Motors 118
- 2.16 Off-board Charging 119
- 2.17 On-board Charging..... 119
- 2.18 Production Test..... 119
- 2.19 Mounting 120
- 2.20 Wire gauges 120



- 2.21 Battery Wiring120
- 2.22 Battery Charging.....120
- 2.23 Programming – Introduction121
- 2.24 Safety Fences.....121
- 2.25 Brake Fault Detect121
- 2.26 Current Limits121
- 2.27 Motor Compensation121
- 2.28 Torque122
- 2.29 Tremor Damping.....122
- 2.30 Mounting.....122
- 2.31 Wiring122
- 2.32 Servicing - Introduction122
- 2.33 Diagnostics - Introduction122
- 2.34 Batteries Discharge Very Quickly.....123
- 2.35 Basic Tests123
- 2.36 Gradient Test123
- 2.36 Servicing of Defective Units.....123

CHAPTER 9 – SPECIFICATIONS..... 125

- 1 Electrical Specifications 125
 - 1.1 VR2 50, 60, 70 & 90125
 - 1.2 VR2 PM 50 & VR2 PM 60.....126
 - 1.3 EMC tested on sample wheelchair:126



ABOUT THIS MANUAL

The Technical Manual gives an introduction to the VR2 Control System.

Throughout the manual icons are used to draw the reader's attention.

The icons used are:



Note - A general point for best practice.



Caution - A point of safety which if ignored could result in damage to the Control System or the vehicle.



Warning - A point of safety which if ignored could cause injury to the individual.

PG Drives Technology accepts no liability for any losses of any kind if the points are not followed.



CHAPTER 1 - OPERATION

1 INTRODUCTION

The relevant contents of this chapter should be included in the wheelchair operating guide. Further copies are available from PGDT in either written or disk (Adobe PDF) format. Copies should not be made without the express permission of PG Drives Technology.

The operation of the VR2 varies dependent on programming. This chapter covers all types of operation. It is the responsibility of the wheelchair manufacturer to ensure that only the relevant sections of this chapter are included in the wheelchair's operating manual.

The operation of the VR2 wheelchair control system is simple and easy to understand. The control system incorporates state-of-the-art electronics, the result of many years of research, to provide you with ease of use and a very high level of safety. In common with other electronic equipment, correct handling and operation of the unit will ensure maximum reliability.

Please read this chapter carefully - it will help you to keep your wheelchair reliable and safe.

2 GENERAL

2.1 HANDLING

Avoid knocking your control system and especially the joystick. Be careful not to strike obstacles with the control system or joystick when you drive. Never drop the control system.

When transporting your wheelchair, make sure that the control system is well protected. Avoid damage to cables.

2.2 OPERATING CONDITIONS

Your control system uses industrial-grade components throughout, ensuring reliable operation in a wide range of conditions. However, you will improve the reliability of the control system if you keep exposure to extreme conditions to a minimum.

Do not expose your control system or its components to damp for prolonged periods. If the control system becomes contaminated with food or drink clean it off as soon as possible.

2.3 CLEANING

Clean the control system and the joystick with a cloth dampened with diluted detergent. Be careful when cleaning the joystick. Never use abrasive or spirit-based cleaners.



3 CONTROLS

The VR2 control system has four versions of the front control panel – with and without actuator control. Most of the controls are common to all versions, however, the actuator buttons are only included on VR2 control systems with seat actuator control. Each of the controls is explained within this section. For Lighting controls refer to Chapter 5.

Joystick Module

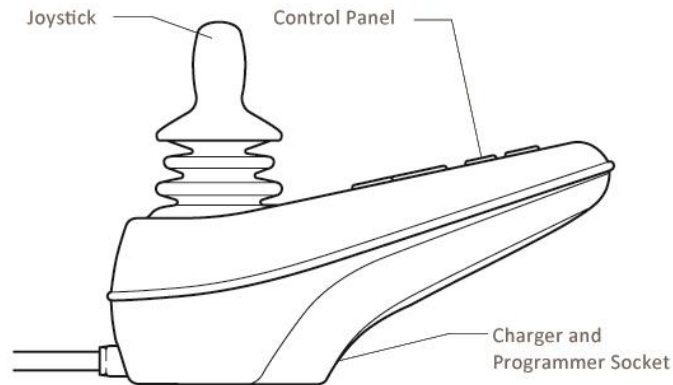

Control Panel Variants

No Actuator

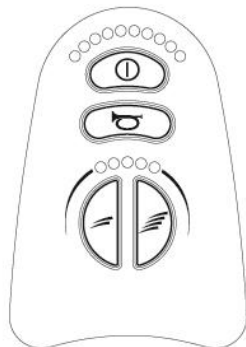

With Actuators

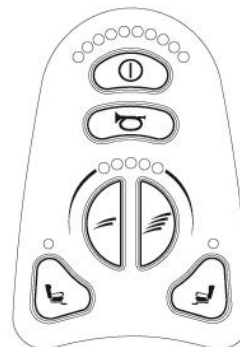

Controls



Battery Gauge

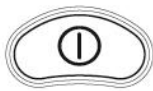

On/Off Button



Horn Button



Maximum Speed / Profile Indicator

Speed / Profile Decrease Button

Speed / Profile Increase Button

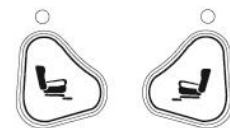

Actuator Buttons



3.1 ON/OFF BUTTON AND BATTERY GAUGE

The on/off button applies power to the control system electronics, which in turn supply power to the wheelchair's motors. Do not use the on/off button to stop the wheelchair unless there is an emergency. (If you do, you may shorten the life of the wheelchair drive components).

The battery gauge shows you that the wheelchair is switched on. It also indicates the operating status of the wheelchair. Details are given in section 8.0.

3.2 LOCKING / UNLOCKING THE WHEELCHAIR

The VR2 control system can be locked to prevent unauthorized use. The locking method is via a sequence of key presses and joystick movements, as detailed below.

To lock the wheelchair;

- While the control system is switched on, depress and hold the on/off button.
- After 1 second the control system will beep. Now release the on/off button
- Deflect the joystick forwards until the control system beeps.
- Deflect the joystick in reverse until the control system beeps.
- Release the joystick, there will be a long beep.
- The wheelchair is now locked.

To unlock the wheelchair;

- Use the on/off button to switch the control system on. The maximum speed / profile indicator will be rippling up and down.
- Deflect the joystick forwards until the control system beeps.
- Deflect the joystick in reverse until the control system beeps.
- Release the joystick, there will be a long beep.
- The wheelchair is now unlocked.

3.3 JOYSTICK

The primary function of the joystick is to control the speed and direction of the wheelchair. The further you push the joystick from the center position the faster the wheelchair will move. When you release the joystick the brakes are automatically applied.

If the wheelchair is fitted with actuators, the joystick can also be used to select and move actuators, refer to section 3.8 for more details.



3.4 MAXIMUM SPEED / PROFILE INDICATOR

This is a gauge which shows the maximum speed setting for the wheelchair or, if the control system is programmed for drive profile operation, the selected drive profile. For more information on drive profiles, refer to Chapter 4.

This gauge also indicates if the speed of the wheelchair is being limited or if the control system is locked, refer to sections 8.8 and 8.9.

3.4.1 MAXIMUM SPEED INDICATOR

This is a gauge that shows the maximum speed setting of the wheelchair. There are five speed settings – step 1 is the lowest speed and step 5 is the highest speed. For details of how to change the maximum speed setting, see sections 3.6 and 3.7.

3.4.2 PROFILE INDICATOR

This is an indicator that shows the selected drive profile. There may be up to 5 drive profiles available, this depends on the programming of the control system (refer to Chapter 4). For details of how to select drive profiles, see sections 3.6 and 3.7.

3.5 HORN BUTTON

The horn will sound while this button is depressed.

3.6 SPEED / PROFILE DECREASE BUTTON

This button decreases the maximum speed setting or, if the control system is programmed for drive profile operation, selects a lower drive profile.

It is possible to program the control system so this button has no effect while the wheelchair is being driven, refer to Chapter 4.

3.7 SPEED / PROFILE INCREASE BUTTON

This button increases the maximum speed setting or, if the control system is programmed for drive profile operation, selects a higher drive profile.

It is possible to program the control system so this button has no effect while the wheelchair is being driven, refer to Chapter 4.

3.8 ACTUATOR BUTTONS AND LEDS

Depending on whether the wheelchair is fitted with one or two actuators, the operation of these buttons will differ. Refer to the relevant section below.

3.8.1 WHEELCHAIRS WITH ONE ACTUATOR

Depressing either actuator button will enter actuator adjustment mode. This will be indicated by the illumination of both actuator LEDs. Actuator adjustment can then be made by deflecting the joystick. To re-enter drive mode, depress either actuator button.

3.8.2 WHEELCHAIRS WITH TWO ACTUATORS

Depressing either actuator button will enter actuator adjustment mode. If the left button was depressed the associated LED will be illuminated, and deflection of the joystick will adjust the actuator motor connected to that channel. If the right button was depressed the associated LED will be illuminated and deflection of the joystick will adjust the actuator connected to the other channel.

To re-enter drive mode depress the selected actuator button, as indicated by the associated LED.

To select the other actuator, depress the opposite actuator button. It is also possible to select the other actuator by left or right movements of the joystick. This alternative selection method is dependent on the programming of the control system, see Chapter 3.

Joystick Actuator Adjustment

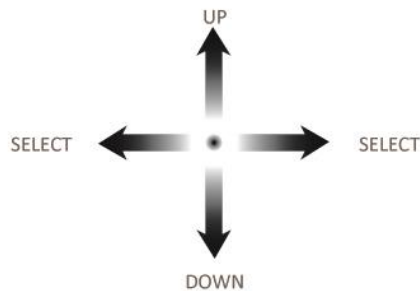

3.9 CHARGER AND PROGRAMMER SOCKET

This socket should only be used for programming and charging the wheelchair. Refer to section 10 for more details.

This socket should not be used as a power supply for any other electrical device. Connection of other electrical devices may damage the control system or affect the E.M.C. performance of the wheelchair.



The control system's warranty will be voided if any device other than a PG Drives Technology Programmer, or the battery charger supplied with the wheelchair, is connected into this socket.

4 GETTING READY TO DRIVE

- Operate the on/off switch. The battery gauge will blink then remain on after a second.
- Check that the maximum speed control is set to a level which suits you.
- Push the joystick to control the speed and direction of the wheelchair.



If you push the joystick before or just after you switch the control system on, the battery gauge will ripple up and down and the wheelchair will not be allowed to move. You must release the joystick to resume normal operation. If you do not release the joystick within five seconds the wheelchair will not be able to move, even if you release the joystick and push it again. The battery gauge will then flash rapidly. You can reset this condition by switching the control system off and on again.

If the battery gauge flashes rapidly, then the VR2 has detected a problem somewhere in the wheelchair's electrical system. Refer to section 8.5 for details.

5 TIPS FOR USING YOUR CONTROL SYSTEM

5.1 DRIVING - GENERAL

Make sure that the control system is mounted securely and that the joystick position is correct. The hand or limb you use to operate the joystick should be supported, for example by the wheelchair arm pad. Do not use the joystick as the sole support for your hand or limb - wheelchair movements and bumps could upset your control.

5.2 DRIVING TECHNIQUE

The control system interprets your joystick movements and produces appropriate movements of your wheelchair. You will need very little concentration to control the wheelchair, which is especially useful if you are inexperienced. One popular technique is to simply point the joystick in the direction you want to go. The wheelchair will "home-in" on the direction you push the joystick.

The further you push the joystick away from the rest position, the faster the wheelchair will go. Releasing the joystick will stop the wheelchair.

The intelligent speed control system minimizes the effects of slopes and different types of terrain.



The wheelchair user must be capable of driving a wheelchair safely. Penny & Giles Controls Limited accepts no liability for losses of any kind arising from failure to comply with this condition.



In the event of the wheelchair moving in an unexpected way RELEASE THE JOYSTICK. This action will stop the wheelchair under any circumstances.

6.1 HAZARDS

Do not drive the wheelchair:

- Beyond restrictions indicated in your wheelchair user manual, for example maximum inclines, curb height etc.
- In places or on surfaces where a loss of wheel grip could be hazardous, for example on wet grassy slopes.
- If you know that the control system or other crucial components require repair.



Although the VR2 control system is designed to be extremely reliable and each unit is rigorously tested during manufacture, the possibility of a system malfunction always exists (however small the probability). Under some conditions of system malfunction the control system must (for safety reasons) stop the chair instantaneously. If there is any possibility of the user falling out of the chair as a result of a sudden braking action, it is imperative that a restraining device such as a seat belt is supplied with the wheelchair and that it is in use at all times when the wheelchair is in motion. Penny & Giles Controls Limited accept no liability for losses of any kind arising from the unexpected stopping of the wheelchair, or from the improper use of the wheelchair or control system.



Do not operate the control system if the chair behaves erratically, or shows abnormal signs of heating, sparks or smoke. Turn the control system off at once and consult your service agent. Penny & Giles Controls Limited accepts no liability for losses of any kind arising from failure to comply with this condition.



Electronic equipment can be affected by Electro Magnetic Interference (EMI). Such interference may be generated by radio stations, TV stations, other radio transmitters and cellular phones. If the chair exhibits erratic behavior due to EMI, turn the control system off immediately and consult your service agent. Penny & Giles Controls Limited accepts no liability for losses of any kind arising from failure to comply with this condition.



It is the responsibility of the chair manufacturer to ensure that the wheelchair complies with appropriate National and International E.M.C legislation. Penny & Giles Controls Limited accepts no liability for losses of any kind arising from failure to comply with this condition.



The wheelchair user must comply with all wheelchair safety warnings. Penny & Giles Controls Limited accepts no liability for losses of any kind arising from failure to comply with this condition.



7 SAFETY CHECKS

The electronic circuits in your control system have been designed to be extremely safe and reliable. The on-board microcomputer carries out safety checks at up to 100 times per second. To supplement this safety monitoring you should carry out the following periodic checks.

If the control system fails any of these checks, do not use the wheelchair and contact your service agent.

7.1 DAILY CHECKS

Joystick: With the control system switched off, check that the joystick is not bent or damaged and that it returns to the center when you push and release it. If there is a problem do not continue with the safety checks and contact your service agent.

7.2 WEEKLY CHECKS

Solenoid (parking) brake:

This test should be carried out on a level floor with at least one meter clear space around the wheelchair.

- Switch on the control system.
- Check that the battery gauge remains on, or flashes slowly, after one second.
- Push the joystick slowly forwards until you hear the parking brakes operate. The chair may start to move.
- Immediately release the joystick. You must be able to hear each parking brake operate within a few seconds.
- Repeat the test a further three times, pushing the joystick slowly backwards, left and right.

Connectors: Make sure that all connectors are securely mated.

Cables: Check the condition of all cables and connectors for damage.

Joystick gaiter: Check the thin rubber gaiter or boot, around the base of the joystick shaft, for damage or splitting. Check visually only, do not handle the gaiter.

Mounting: Make sure that all the components of the control system are securely mounted. Do not over-tighten any securing screws.

7.3 SERVICING

To ensure continued satisfactory service, we suggest you have your wheelchair and control system inspected by your service agent after a period of 1 year from commencement of service. Contact your service agent for details when the inspection is due.



8 CONTROL SYSTEM STATUS INDICATION

The battery gauge and maximum speed /profile indicator show the status of the control system.



A number of supposedly defective control systems returned to us are subsequently found to operate correctly. This indicates that many reported faults are due to wheelchair problems rather than the control system.

8.1 BATTERY GAUGE IS STEADY

This indicates that all is well.

8.2 BATTERY GAUGE FLASHES SLOWLY

The control system is functioning correctly, but you should charge the battery as soon as possible.

8.3 BATTERY GAUGE STEPS UP

The wheelchair batteries are being charged. You will not be able to drive the wheelchair until the charger is disconnected and you have switched the control system off and on again.

8.4 BATTERY GAUGE FLASHES RAPIDLY (EVEN WITH THE JOYSTICK RELEASED)

The control system safety circuits have operated and the control system has been prevented from moving the wheelchair.

This indicates a system trip, i.e. the VR2 has detected a problem somewhere in the wheelchair's electrical system. Please follow this procedure:

- Switch off the control system.
- Make sure that all connectors on the wheelchair and the control system are mated securely.
- Check the condition of the battery.
- If you can't find the problem, try using the self-help guide given in section 8.5.
- Switch on the control system again and try to drive the wheelchair. If the safety circuits operate again, switch off and do not try to use the wheelchair.

Contact your service agent.













8.5 SELF-HELP GUIDE

If a system trip occurs, you can find out what has happened by counting the number of bars on the battery gauge that are flashing.

Below is a list of self-help actions. Try to use this list before you contact your service agent. Go to the number in the list which matches the number of flashing bars and follow the instructions.

If the problem persists after you have made the checks described above contact your service agent.

- | | |
|--|--|
| 1 LED
 | The battery needs charging or there is a bad connection to the battery. Check the connections to the battery. If the connections are good, try charging the battery. |
| 2 LED
 | The left hand motor* has a bad connection. Check the connections to the left hand motor. |
| 3 LED
 | The left hand motor* has a short circuit to a battery connection. Contact your service agent. |
| 4 LED
 | The right hand motor* has a bad connection. Check the connections to the right hand motor. |
| 5 LED
 | The right hand motor* has a short circuit to a battery connection. Contact your service agent. |
| 6 LED
 | The wheelchair is being prevented from driving by an external signal. The exact cause will depend on the type of wheelchair you have, one possibility is the battery charger is connected. |
| 7 LED
 | A joystick fault is indicated. Make sure that the joystick is in the center position before switching on the control system. |
| 8 LED
 | A possible control system fault is indicated. Make sure that all connections are secure. |
| 9 LED
 | The parking brakes have a bad connection. Check the parking brake and motor connections. Make sure the control system connections are secure. |
| 10 LED
 | An excessive voltage has been applied to the control system. This is usually caused by a poor battery connection. Check the battery connections. |

**7 LED+ S**

A communication fault is indicated. Make sure that the joystick cable is securely connected and not damaged.

8 Bar + A

An Actuator trip is indicated. If more than one actuator is fitted, check which actuator is not working correctly. Check the actuator wiring.

* If the programmable parameter, Motor Swap has been enabled, then left and right hand references in this table will need transposing.

8.6 SLOW OR SLUGGISH MOVEMENT

If the wheelchair does not travel at full speed or does not respond quickly enough, and the battery condition is good, check the maximum speed setting. If adjusting the speed setting does not remedy the problem then there may be a non-hazardous fault.

Contact your service agent

8.7 SPEED / PROFILE INDICATOR IS STEADY

The display will vary slightly depending on whether the control system is programmed to operate with drive profiles. For more information on drive profiles, refer to Chapter 4.

8.7.1 SPEED INDICATION

The number of LEDs illuminated shows the maximum speed setting. For example, if the setting is speed level 4, then the four left hand LEDs will be illuminated.

8.7.2 PROFILE INDICATION

The LED illuminated shows the selected drive profile. For example, if drive profile 4 is selected, then the fourth LED from the left will be illuminated.

8.8 SPEED / PROFILE INDICATOR RIPPLES UP AND DOWN

This indicates the control system is locked, refer to section 3.2 for details of how to unlock the control system.

8.9 SPEED / PROFILE INDICATOR FLASHES

This indicates the speed of the wheelchair is being limited for safety reasons. The exact reason will depend on the type of wheelchair, however, the most common cause is that the seat is in the elevated position.

8.10 ACTUATOR LED FLASHES

This indicates that the Actuator(s) may be inhibited in one or both directions. Refer to Chapter 4 for programming details.

9 BATTERY GAUGE

The battery gauge is included to let you know how much charge is left in your batteries. The best way for you to use the gauge is to learn how it behaves as you drive the wheelchair. Like the fuel gauge in a car, it is not completely accurate, but it will help you avoid running out of “fuel”.

The battery gauge works in the following way:

When you switch on the control system, the battery gauge shows an estimate of the remaining battery charge.

The battery gauge gives you a more accurate reading about a minute after you start driving the wheelchair.



When you replace worn out batteries, fit the type recommended by the wheelchair manufacturer. If you use another type the battery gauge may be inaccurate.

The amount of charge in your batteries depends on a number of factors, including the way you use your wheelchair, the temperature of the batteries, their age and the way they are made. These factors will affect the distance you can travel in your wheelchair. All wheelchair batteries will gradually lose their capacity as they age.

The most important factor that reduces the life of your batteries is the amount of charge you take from the batteries before you recharge them. Battery life is also reduced by the number of times you charge and discharge the batteries.

To make your batteries last longer, do not allow them to become completely flat. Always recharge your batteries promptly after they are discharged.

If your battery gauge reading seems to fall more quickly than usual, your batteries may be worn out.

9.1 HOW TO READ A TRUCHARGE BATTERY GAUGE

If the battery gauge shows red, yellow and green, the batteries are charged.

If the battery gauges show just red and yellow, then you should charge the batteries as soon as you can.

If the battery gauge shows just red, either steady or flashing slowly, then you should charge the batteries immediately.



Do not operate the control system if the battery is nearly discharged. Failure to comply with this condition may leave the user stranded in an unsafe position, such as in the middle of a road. Penny & Giles Controls Limited accepts no liability for losses of any kind arising from failure to comply with this condition.

10 BATTERY CHARGING

To charge the wheelchair batteries connect the charger plug into the battery charging socket on the VR2. You will not be able to drive the wheelchair when the charger is connected.

To connect the charger plug, ensure the single pin is at the bottom, as shown in the following illustration, then offer the charger plug to the VR2 in a horizontal orientation. The molded guide on the VR2 will help you to locate the plug. Ensure the plug is pushed fully in position.

Charger Connection

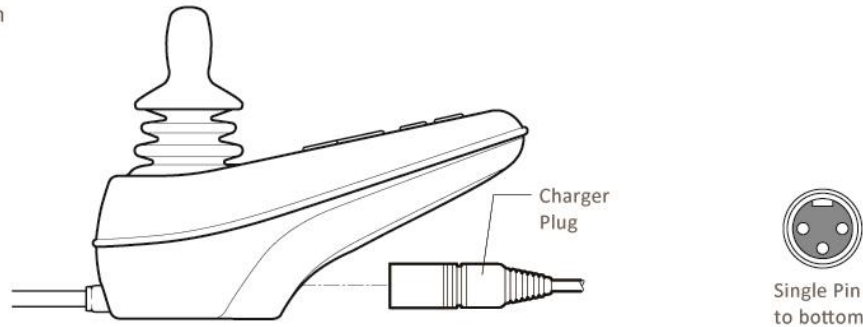

- 

Do not exceed the maximum charging current. For D51427 the maximum charging current is 6Arms, for all other VR2 JSMs it is 12 Arms. Always use an off-board charger fitted with a Neutrik NC3MX plug. Failure to observe these conditions could result in poor contact resistance in the charger connector resulting in overheating of the charger plugs. This presents a potential burn hazard for the user. Penny & Giles Controls Limited accepts no liability for losses of any kind arising from failure to comply with this condition.
- 

Ensure that the charger plug pins are of the correct polarity with that shown on the specific control system's data sheet. Failure to observe this condition could result in a burn hazard or fire hazard. Penny & Giles Controls Limited accepts no liability for losses of any kind arising from failure to comply with this condition.
- 

Do not disconnect batteries or open-circuit the circuit breaker while charging is in progress. Failure to observe this condition could result in a burns hazard or fire hazard. Penny & Giles Controls Limited accepts no liability for losses of any kind arising from failure to comply with this condition.
- 

Only use the battery charger that has been supplied with your wheelchair. The use of incorrect chargers could damage the batteries, wheelchair, control system or charger itself, or may result in parts overheating creating the potential for burns or even fire. Penny & Giles Controls Limited accepts no liability for losses of any kind if the charger is incompatible with the control system (see Chapter 2, section 8) or any other part of the wheelchair system.

11 PROGRAMMING

If you cannot find a maximum speed control setting that suits you, the control system can be programmed to meet your needs. Programming can be performed using a PP1a, DTT Hand-held Programmer or specialist PC software and interface cable.



The PP1a and DDT are hand-held units which can be plugged into your controller to alter the controller's programming. Your wheelchair distributor or service agent or wheelchair manufacturer will be able to program your controller for you.

If you have a PP1a or DTT, read the user guide before you use it.

If you re-program your control system, make sure that you observe any restrictions given in your wheelchair user manual. Note any changes you make for future reference.



Programming should only be conducted by healthcare professionals with in-depth knowledge of Penny & Giles Controls Limited electronic control systems. Incorrect programming could result in an unsafe set-up of a wheelchair. Penny & Giles Controls Limited accepts no liability for losses of any kind if the programming of the control system is altered from factory pre-set values.

12 JOYSTICK KNOBS

The knob fitted to your joystick is suitable for most applications. If you would prefer another type, there is a range of alternatives available. Please contact your wheelchair distributor or manufacturer for advice. Do not replace the joystick knob with any unauthorized item - it may cause hazardous operation.



Do not replace the joystick knob with any unauthorized item It may cause hazardous operation. Penny & Giles Controls Limited accepts no liability for losses of any kind arising from failure to comply with this condition.

13 SERVICING

All repairs and servicing must be carried out by authorized service personnel. Opening or making any unauthorized adjustments or modifications to the control system or its components will invalidate any warranty and may result in hazards to yourself or other people, and is strictly forbidden. It is possible to replace the cable and the joystick, by following instructions laid down by PG Drives Technology. Refer to Chapter 7 – Servicing & Diagnostics.



Penny & Giles Controls Limited accept no liability for losses of any kind arising from unauthorized opening, adjustment or modifications to the VR2 control system.



If the control system is damaged in any way, or if internal damage may have occurred through impact or dropping, have the product checked by qualified personnel before operating. Penny & Giles Controls Limited accepts no liability for losses of any kind arising from failure to comply with this condition.

14 WARRANTY

The VR2 control system is covered by a warranty period defined by the wheelchair manufacturer. For details of the warranty period, please contact your service agent.

The warranty will be void if the VR2 control system has:



- Not been used in accordance with the VR2 control system Technical Manual, SK77898.
- Been subject to misuse or abuse.
- Been modified or repaired by non-authorized persons.



The warranty will be void if the VR2 has not been used in accordance with VR2 Technical Manual SK77898, the VR2 has been subject to misuse or abuse, or if the VR2 has been modified or repaired by unauthorized persons.



CHAPTER 2 - INSTALLATION

1 DOCUMENTATION

1.1 VR2 OPERATION



This chapter must be read in conjunction with chapter 3 when installing D51425, D51426 and D51427.

Study Chapters 1, 2, 3 and 4. It is important that the operation information in these chapters is supplied with the wheelchair, either as part of the wheelchair user handbook or as a separate document.

This chapter sets out the installation conditions that must be complied with in order to meet the safety requirements of TÜV (Germany), ISO7176-14 and EN12184.

1.2 PROGRAM SETTINGS

The VR2 control system is supplied with PGDT defined generic program settings.



It is the manufacturer's responsibility to program the control system to suit the vehicle model and ensure safe operation in compliance with relevant legal requirements over the whole of the operating range. Penny & Giles Controls Limited accepts no liability for losses of any kind due to incorrect programming or the VR2 Control System. Refer to Chapter 4 for programming details.

The wheelchair must stop within the maximum distance specified for the country in which the wheelchair will be used. TÜV Product Service (Germany) specify the distance to be as stated in EN12184.

If users with particular disabilities need very low braking rates and this results in a longer stopping distance, the maximum speed must be re-programmed so that the stopping distance requirement is satisfied.

State in the wheelchair user handbook that it is the responsibility of the person programming the control system to make sure that the stopping distance requirement is satisfied. If the braking rate is low, the forward and reverse maximum speed settings may need to be re-programmed. To assist the person in this task, include a graph in the wheelchair user handbook showing the relationship between the maximum forward/reverse speed settings and the forward/reverse braking rate which is required to ensure the correct stopping distance.

It may be possible to program settings which compromise the stability of the wheelchair. Perform suitable tests to establish which programming restrictions are needed to prevent instability. State any programming restrictions in the wheelchair user handbook.

State in the wheelchair user handbook that it is the responsibility of the person programming the control system to make sure that the settings are safe and to note any programming changes that they make.



Programming should only be conducted by healthcare professionals with in-depth knowledge of Penny & Giles Controls Limited electronic control systems. Incorrect programming could result in an unsafe set-up of



a wheelchair for the user. Penny & Giles Controls Limited accepts no liability for losses of any kind due to failure to, or incorrect programming or the VR2 Control System.

1.3 SOFT-STOP

The VR2 has a programmable value called Soft Stop Rate which sets the emergency stopping distance. You must ensure that the emergency stopping distance is within the distance specified for the country in which the wheelchair will be used. TÜV Product Service (Germany) specify the distance to be as stated in EN12184.

1.4 OTHER INFORMATION

You must provide a diagram in the wheelchair user handbook showing the user controls and the main features of the control system.

In addition, you should include a brief specification of operating supply voltage range and operating temperature range.

1.5 CONTROL SYSTEM MAKE-UP

The VR2 Control System is made-up of a minimum of 2 modules, the Joystick Module and the Power Module. The following table shows the relationship between the two modules.

Power Module	Description	Joystick Module Options
VR2 50	50A Output, No Actuators	JSM/JSM-L
VR2 60	60A Output, No Actuators	JSM/JSM-L
VR2 60 (A1)	60A Output, 1 Actuator	JSM-A / JSM-A-L
VR2 60 (A2)	60A Output, 2 Actuators	JSM-A / JSM-A-L
VR2 70	70A Output, No Actuators	JSM / JSM-L
VR2 70 (A1)	70A Output, 1 Actuator	JSM-A / JSM-A-L
VR2 70 (A2)	70A Output, 2 Actuators	JSM-A / JSM-A-L
VR2 90	90A Output, No Actuators	JSM / JSM-L
VR2 90 (A2)	90A Output, 2 Actuator	JSM-A / JSM-A-L

2 IMMOBILIZING THE WHEELCHAIR

2.1 PREVENTION OF UNAUTHORIZED USE

TÜV requires that the wheelchair must have a means of preventing unauthorized use. This can be implemented electronically using the button and joystick sequence detailed in Chapter 1 section 3.2. This method of locking has been chosen to prevent problems arising from lost keys.

Alternatively, an external switch which interrupts the battery or solenoid brake circuit, or provides a drive inhibit, can be fitted.

2.2 CHARGER INTERLOCK

ISO 7176-14 requires you to provide a means of preventing the use of the wheelchair while the batteries are being charged. The charger socket and on-board charger connection fitted to the PG Drives Technology VR2 control systems include an inhibit facility. Refer to section 9 for details.

Contact PG Drives Technology if you need advice.



The chair manufacturer is responsible for providing a means of preventing the use of the wheelchair while the batteries are being charged. Penny & Giles Controls Limited accepts no liability for losses of any kind arising from failure to comply with this condition.

3 MOUNTING

3.1 JOYSTICK MODULE

The VR2 Joystick Module has two holes for mounting on the underside. The holes are tapped with an M5 thread allowing for a maximum screw penetration depth of 8mm (5/16"). Refer to the following diagram.

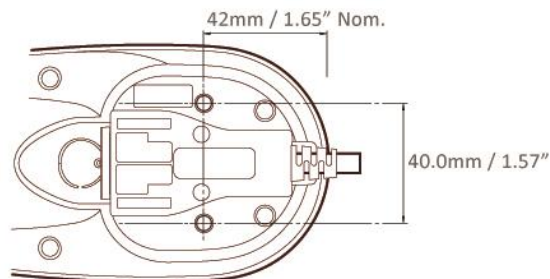

View of Underside

3.1.1 ORIENTATION

The control system is not sensitive to mounting orientation except where it is exposed to water or dust. In this situation the control system must be mounted with the joystick shaft pointing vertically upwards to maintain resistance to IPx4 as stated on the data sheet:

If you want to use any other mounting attitudes then contact PGDT for advice.

3.2 POWER MODULE MOUNTING

Fix the Power Module to the wheelchair chassis using suitable M5 or equivalent hardware.

3.2.1 ORIENTATION

The function of the Power Module is not sensitive to mounting orientation; however, it should be mounted in such a way that water cannot enter and remain in the connector recesses. It is recommended that the unit is not mounted with the connectors uppermost. The Power Module has an IPX4 dust and water resistance rating.

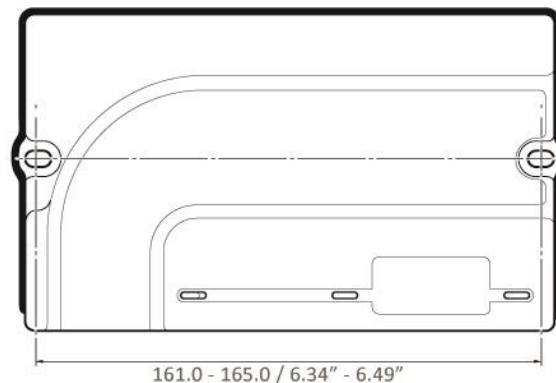

3.2.2 POSITION

The Power Module must be mounted in a position where it is not exposed to conditions of water or dust above those specified in ISO7176/9.

The Power Module has excellent thermal performance but, to improve this further, it may be secured against a metal part of the wheelchair chassis. To provide even better thermal performance, a non-silicone thermally conductive paste or pad may be applied between the Power Module and the wheelchair chassis.

Mount the control system in a position allowing a free flow of air around the case.



It is possible for the case temperature of the Power Module to rise above 41°C (107°F). For this reason the Power Module should be fixed in a position where it cannot be touched by the wheelchair user. Chapter 5 section 3.1.

Contact PGDT if you need further advice.

3.2.3 CABLES

The cables to the Power Module must be routed and secured in such a way as to prevent damage to them, for example by cutting or crushing.

4 CONNECTIONS

There are 9 generic VR2 Power Module configurations. Each Power Module includes a Joystick connector, a battery connector, 2 motor connectors (Left and Right), an on-board charger, an individual inhibit input and up to 2 actuator control connections.



On Power Modules with less than 2 Actuator Connections, the un-populated connectors will be blanked off.

VR2 60 & VR2 70

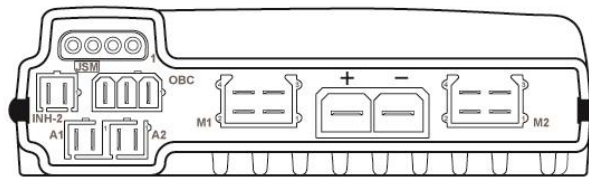

VR2 70-RN & VR2 90

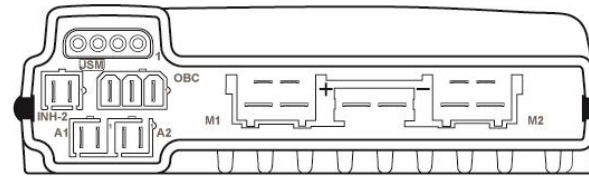

Connection

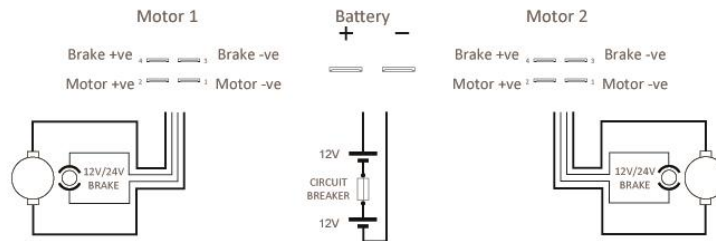

Inhibit 2



INH-2	Function
1	0V
2	Inhibit 2

On-board Charger



OBC	Function
1	Battery +ve
2	Inhibit 3
3	0V

Actuators

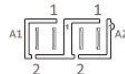

Joystick Movement	Pin 1	Pin 2	Actuator Movement
Forward	+ve	-ve	Channel Up
Backward	-ve	+ve	Channel Down



4.1 CRIMPING

Good quality crimping is essential in ensuring the long term reliability of the wheelchair's electrical system. Poor quality crimps may initially appear to be satisfactory but, over time, they may cause problems. It is recommended that crimp quality is maintained by implementing the procedures detailed in IEC-60352-2 1990.



Defective or poor quality crimps may affect the warranty of the control system. Penny & Giles Controls Limited accepts no liability for losses of any kind arising from failure to comply with this condition.

4.2 CONNECTOR KITS

The connector kits can be purchased from PG Drives Technology, or from Inconnect directly. Inconnect details are as below.

Inconnect UK
+44 (0) 845 25 70 666
www.inconnect.uk.net

Avertronics INC (Taiwan)
+886 (0)4 2358 1581
www.inteam.ws

Connector Kits	PGDT Reference	Inconnect Reference
Motor	D50750	IPG-7401-PS
Battery	D50751	IPG-7401-PS
Motor (90)	D49713 PG80-M	IPG-5401
Battery (90)	D49712 PG80-B	IPG-5402
On Board Charger	D50752	IPG-7301-PS
Inhibit 2	D50753	IPG-8201-PS
Actuator	D50754	IPG-8202-PS

Hand tools for crimping and extraction are available from Inconnect. The references are as follows.

Crimp tool for 0.5-1.0mm² wire: ICT-29020
Crimp tool for 4.0-6.0mm² wire: ICT-29030
Extraction tool for 0.5-1.0mm²: IET-503
Extraction tool for 4.0-6.0mm²: IET-560



Only use the exact tools as specified.

For details of automatic crimp tools contact Inconnect.

5 WIRING

5.1 GENERAL

Study the data sheet for the control system to identify:

- The output current, ratings and restrictions
- The connector pin assignments

Recommendations for the cross-sectional area, ratings and materials for wiring are given in the table in section 5.2. These are dependent on the application. You are responsible for establishing the suitability of the particular wiring arrangement used on the wheelchair. PGDT can make general recommendations for wiring for VR2 control systems, but PGDT accepts no responsibility for the wiring arrangement used.

Make sure that the connectors you use are reliable under all operating conditions and correctly wired with no short circuits. Do not use unsuitable components - it may result in poor wheelchair reliability.



The chair manufacturer is responsible for establishing the suitability of the particular wiring arrangements used on the wheelchair, for both normal use and stalled conditions. Penny & Giles Controls Limited can make general recommendations for wiring of VR2 control systems, but Penny & Giles Controls Limited accepts no responsibility or liability for losses of any kind arising from the actual wiring arrangement used.



The chair manufacturer is responsible for ensuring that only the mating connectors specified by Penny & Giles Controls Limited on the control system's specific data sheet are used to connect to the control system. Penny & Giles Controls Limited accepts no liability for losses of any kind arising from failure to comply with this condition.



The chair manufacturer is responsible for ensuring that suitable connectors are used and securely mated throughout the chair wiring system and also for the quality of the wiring system. Failure to meet this condition could result in intermittent operation, sudden stopping or veering and even create a burn or fire hazard. Penny & Giles Controls Limited accepts no liability for losses of any kind arising from failure to comply with this condition.

5.2 WIRE GAUGE AND TYPES

The table below gives the minimum recommended wire sizes defined in ISO7176: 2008.

Controller Current Limit (A)	Battery wire size (mm ²)		Motor Wiring size (mm ²)	
	For Length <1000mm	For length 1000mm - 1500mm	For Length <1000mm	For length 1000mm - 1500mm
60	6.0	6.0	3.0	4.0
80	6.0	8.0	4.0	5.0
100	6.0	No guidance	6.0	6.0



Penny & Giles Controls Limited recommend 0.5mm² PVC for the brake connections. Battery, motor, brake and on-board charger wires should use PVC coated wire rated to UL1569.

5.3 BATTERY WIRING

The control system incorporates sophisticated current limiting circuitry as protection for the circuits in the control system.

ISO 7176-14 requires you to provide protection against short circuits in the battery wiring and the power loom or in the extremely unlikely event of a short circuit in the control system.

Place a suitable circuit breaker in series with the battery supply (refer to section 4.2), for example in the link between two 12V batteries. If your batteries are held in separate enclosures, you must provide a circuit breaker with each of them.

The rating of the circuit breaker must match the capacity of the wiring used. We recommend the use of a 70A circuit breaker for VR2 60 & 70A systems and a 90A circuit breaker for VR2 90A systems. This recommendation is derived from well proven field experience of various international wheelchair manufacturers. Nevertheless, manufacturers must confirm these recommendations by carrying out suitable tests.

ISO 7176-14 states that the minimum operating time for the circuit breaker when the wheelchair is stalled is 15 seconds.



The chair manufacturer must install a suitable circuit breaker to provide protection against short circuits in the battery wiring, power loom or the control system. Failure to comply with this could result in a fire hazard. Penny & Giles Controls Limited accepts no liability for losses of any kind arising from failure to comply with this condition.

5.4 MOTOR WIRING

In order to detect the disconnection of a motor while the wheelchair is in motion, the brake current must pass through the same connectors as the motor current, so that disconnection of either motor will interrupt the brake circuit and trip the control system. Refer also to section 5.5.

When the control system is starting up or standing by, it is able to detect a disconnected motor or a short circuit between a motor connection and either battery supply. With the TruCharge battery gauge, the number of flashing bars indicates the type of trip.

Auxiliary switches will disconnect the brake circuit if either circuit breaker operates. In this way the control system can detect that the motor has been disconnected and stop the wheelchair. Should the motor be put into a stalled condition, the timed current foldback facility in the control system can also be used to offer some level of motor protection.

5.5 SOLENOID BRAKE WIRING

The control system will be immobilized instantly if the brake current is less than approximately 100mA.

- The maximum continuous current is 1A.

The VR2 control system can be programmed to operate with either 12 or 24V brakes. Refer to Chapter 4 for programming details.

6 DRIVE MOTORS

The control system is designed to be connected to permanent magnet DC motors, fitted with suitable gearboxes and solenoid brakes.

In order to optimize the performance of the wheelchair, the control system must be matched to the motor terminal impedance. This matching is implemented by programming the control system. The parameter for adjustment is Motor Compensation. Refer to Chapter 4 for details.

The Motor Compensation value should be set in accordance with the armature resistance of the motor and all cables and connectors between the VR2 and the motor. The value is set in milli-Ohms ($m\Omega$). A recommended value is:

- 70% of the (armature resistance + cables and connectors)

Motor manufacturers should be able to supply figures for armature resistance and cable and connectors may typically be $40m\Omega$.

Example:

Motor has armature resistance of $200m\Omega$

Cables and connectors are $40m\Omega$

Set Motor Compensation to $0.7 \times (200 + 40) = 170m\Omega$

Failure to match the control system with the motors may result in poor control characteristics.

If you have any doubts about the suitability of a particular motor type or you need advice on measuring motor impedance, contact PGDT.



The chair manufacturer is responsible for ensuring that the control system is matched to the motor resistance. Failure to do this may result in poor control characteristics, which in extreme instances can make a chair uncontrollable and potentially unsafe. Penny & Giles Controls Limited accepts no liability for losses of any kind arising from failure to comply with this condition.



The chair manufacturer is responsible for always ensuring that any replacement motors or gearboxes are fully compatible with the originals that the control system was designed to match. Failure to do this may result in poor control characteristics, which in extreme instances can make a chair uncontrollable and potentially unsafe. Penny & Giles Controls Limited accepts no liability for losses of any kind arising from failure to comply with this condition.



Users must not move a control system from one chair type to install it on a different chair type. Control systems with different part numbers may have both hardware and software differences to ensure that they are compatible with the electrical and dynamic characteristics of their specific target vehicles. The characteristics of one type of control system may not be compatible with a different, unauthorized chair. Failure to observe this warning could result in an unsafe set-up for the wheelchair user and may create a fire hazard depending on the motors, wiring, connectors and circuit breakers installed on the unauthorized chair. Penny & Giles Controls Limited accepts no liability for losses of any kind arising from failure to comply with this condition.



7 BATTERIES

The control system is designed for operation with 24 V lead acid batteries. The batteries may be wet or gel electrolyte types.

Contact PGDT for advice on battery selection.

8 BATTERY CHARGING

The VR2 control system supports both on-board and off-board methods of battery charging. While the battery is being charged the VR2's TruCharge display will continuously ripple or step upwards. The two methods of charging are described in the following sections.

8.1 OFF-BOARD CHARGING

All VR2 control systems have a battery charging socket mounted on their front face for connection to an off-board charger.

The maximum permissible charging current is 12A rms. Only chargers fitted with Neutrik NC3MX plugs should be connected into the VR2 control system. The pin connections of the socket are as below.

Pin	Connection
1	Battery Positive
2	Inhibit
3	Battery Negative

To prevent the wheelchair from driving while the charger is connected, pin 3 must be linked to pin 2 inside the charger's plug.



Do not exceed the maximum charging current of 12A rms. Always use an off-board charger fitted with a Neutrik NC3MX plug. Failure to observe these conditions could result in poor contact resistance in the charger connector resulting in overheating of the charger plugs. This presents a potential burn hazard for the user. Penny & Giles Controls Limited accepts no liability for losses of any kind arising from failure to comply with this condition.



Ensure that the charger plug pins are of the correct polarity to be compatible with the pin polarity shown on the control system's specific data sheet. Failure to observe this condition could result in a burn hazard or fire hazard. Penny & Giles Controls Limited accepts no liability for losses of any kind arising from failure to comply with this condition.



Do not disconnect batteries or open-circuit the circuit breaker while charging is in progress. Failure to observe this condition could result in a burns hazard or fire hazard. Penny & Giles Controls Limited accepts no liability for losses of any kind arising from failure to comply with this condition.

8.2 ON-BOARD CHARGING

The VR2 control systems have a 3 way connector for connection to an on-board battery charger. Refer to section 4 for connector details.



The maximum permissible charging current is 12A rms.

For details of how to provide a suitable inhibit function, refer to section 9.



Do not exceed the maximum charging current of 12 A rms. Always use an on-board charger fitted with the Inconnect parts specified in section 4.2. Penny & Giles Controls Limited accepts no liability for losses of any kind arising from failure to comply with this condition.



Ensure that the charger plug pins are of the correct polarity to be compatible with the pin polarity shown on the control system's specific data sheet. Failure to observe this condition could result in a burn hazard or fire hazard. Penny & Giles Controls Limited accepts no liability for losses of any kind arising from failure to comply with this condition.



Do not disconnect batteries or open-circuit the circuit breaker while charging is in progress. Failure to observe this condition could result in a burns hazard or fire hazard. Penny & Giles Controls Limited accepts no liability for losses of any kind arising from failure to comply with this condition.

9 INHIBITS

The VR2 control system contains two highly versatile inputs that can be configured to provides drive inhibit, speed limiting and actuator inhibit functions. These inputs are referred to as Inhibit 2 and Inhibit 3.

Inhibit 2 input is located in the INH-2 connector on the Power Module. Inhibit 3 input is located in the ON-BOARD CHARGER connector on the Power Module. Refer to section 4 - VR2 Connections.

Each input has a number of associated programmable parameters. Refer to Chapter 4 for details on programming.

10 ACTUATOR CONTROL

The VR2 control system has the facility for 2 actuator output channels. Each actuator channel can supply a maximum current of 12A. The VR2 provides automatic end-stop detection for each actuator, see section 10.1.

To ensure correct operation of the user controls for 1 or 2 actuator applications, it is necessary to program the control system accordingly. The parameter for adjustment is Number of Actuators. Refer to Chapter 4 for details of programming.



10.1 ACTUATOR END-STOP DETECTION

The VR2 continuously monitors the actuator drive current so that when the actuator reaches the end of its travel the rise in current is detected and the power to the actuator is automatically shut off. When the actuator current reaches the programmed End Force for a period of time greater than the programmed Actuator Current Limit Timeout the actuator is stopped.

Because of the wide variation in actuator motors and applications, the end-stop current threshold is programmable.

The parameters for adjustment are:

- Actuator 1: Actuator Current Limit Timeout

- Actuator 2: Actuator Current Limit Timeout

- Actuator 1: End Force

- Actuator 2: End Force

Actuator Current Limit Timeout is programmable between 0 and 500 in steps of 10ms.

Actuator End Force is programmable between 1 and 5 in steps of 1.

The values should be chosen so that the actuator can move under its heaviest load condition, but will shut off automatically and consistently when stalled at the end stop.

When the actuator end stop is reached an audible feedback can be programmed. The associated parameter is Actuator End Stop Bleep. Chapter 4 for programming details.

10.2 ACTUATOR INHIBITS

The Inhibits inputs can be used to inhibit the movement range of the actuator channels. You can limit the amount of movement for either actuator channel in either direction by programming Inhibit Bands 0 and or 3.

Refer to chapter 4 for programming details.

10.3 ACTUATOR MOTORS

The VR2 control system is designed to be connected to permanent magnet DC actuator motors. The VR2 may not be compatible with actuators that have their own over-current detection electronics. Actuator assemblies with slipping clutches may also be unsuitable as the motors will never stall, therefore, not allowing the control system to detect the end-stop.

Please contact PGDT if you are unsure.

Large values of capacitance should not be connected across the control system's actuator outputs, as electrical resonance could occur which may affect control system operation. If capacitors are required for E.M.C. purposes, the capacitance value should not exceed 10nF. Section 13 gives more details.

11 PRODUCTION TESTS

Perform the following tests, in order, on each wheelchair before dispatch.



These tests should be conducted in an open space and a restraining device such as a seat belt should always be used. Penny & Giles Controls Limited accepts no liability for losses of any kind arising from failure to comply with this condition.

11.1 MOUNTING

- Make sure that all the control system is securely mounted. Do not over-tighten any securing screws.

11.2 CABLES AND CONNECTORS

- Check all cables and connectors for damage. Make sure that all connectors are securely mated.

11.3 JOYSTICK AND GAITER

- Check that the joystick is not bent or damaged.
- Check the thin rubber gaiter or boot, around the base of the joystick shaft, for damage or splitting. Check visually only, do not handle the gaiter.
- Check that the joystick returns to the center position when you push and release it.

11.4 PRESET SETTINGS

- Make sure that the control system is using the preset settings. Refer to chapter 3 for detailed instructions.

Control Systems are always supplied with the settings shown on the relevant data sheet.

11.5 OPERATIONAL TEST

This test should be carried out on a level floor with at least one meter clear space around the wheelchair.

- Switch on the control system.
- Check that the battery gauge remains on, or flashes slowly, after one second.
- Push the joystick slowly forwards until you hear the parking brakes operate. The chair may start to move.



- Immediately release the joystick. You must be able to hear each parking brake operate within a few seconds.
- Repeat the test a further three times, pushing the joystick slowly backwards, left and right.

11.6 TEST DRIVE

- Drive the wheelchair and make sure that it operates correctly for all positions of the user controls.

11.7 SOFT-STOP TEST

- Drive the wheelchair at full forward speed and switch the control system off.
- The wheelchair must not stop suddenly, but should decelerate to standstill.

In addition, ensure that the requirements in section 1.3 of this chapter are satisfied.

12 ELECTROMAGNETIC COMPATIBILITY (E.M.C.)

The VR2 control system series has been tested for compliance with the EMC requirements of EN12184. The guidelines in this section will help you to make sure that your wheelchair installation will meet the requirements of the directive.

12.1 EMISSIONS

A typical wheelchair and VR2 installation have been type tested and have passed the requirements of EN55022B.

Observe the following recommendations to minimize radio frequency emissions:

12.1.1 MOTOR SUPPRESSION

Solder a suitable suppression capacitor between the brush holders of each motor, inside the motor cases. Keep the lead length as short as possible. We recommend a value of 4n7F 250V AC ceramic. The maximum value you should use is 10nF. A typical type is Roderstein WY0472MCMCF0K.

For 4 pole motors, a capacitor should be fitted between each pair of brushes.

12.1.2 CABLES

You do not need to use screened battery and motor looms, but:

- Keep the length of all wiring to a minimum.



- Make sure the loop area of the wiring is minimized. Route the positive and negative wires to each motor together.
- Route the battery positive and negative wires together. Where possible, route the battery and motor looms together.
- Secure the motor and battery looms to the wheelchair frame over as much of their length as is practical.

12.2 IMMUNITY

The VR2 control system has been stringently tested for susceptibility to electromagnetic radiation over the frequency range 26 MHz to 1 GHz. The test was conducted on a typical wheelchair installation and passed the requirements of EN12184.

Follow the recommendations in section 13 to ensure maximum immunity to electromagnetic radiation.

13 BATTERY GAUGE

For optimum accuracy of the battery gauge and low battery indicator, the control system should be programmed with the approximate nominal capacity of the wheelchair battery. However, accuracy is not greatly affected if the programmed type and capacity do not closely match the battery.

The most important factor affecting the accuracy of the battery gauge is the resistance of the cable and connections between the battery and the control system. The control system must be matched approximately to the cable resistance of your wheelchair to make the battery gauge accurate. The parameter for adjustment is Cable Resistance, refer to Chapter 4 for details on programming

As a guide, 2.5 mm² cable has a resistance of about 8 milliohms per meter; 4 mm² cable has about 5 milliohms per meter. Circuit breakers and connectors usually account for about 15 milliohms.

These values will be chosen at the time the control system is being specified by the wheelchair manufacturer. Like the preset acceleration rates, once the values for the battery are decided, they are programmed into control systems during manufacture and should never need changing.

- Control systems are set for a nominal 40amp hour battery and a 40 milliohm cable resistance.

If you need advice, contact PGDT



CHAPTER 3 – NVR2

1 INTRODUCTION

This Chapter describes the differences of the following modules. It is therefore important that the entire manual has been read and understood.

Major differences are:

- 6A Charging Current
- No On-Board Charging
- Unique Inter Connection System

Modules	Description	PG Part Number
nVR2 PM 50	50A Output, No Actuators	D51425
nVR2 PM 60	60A Output, No Actuators	D51426
nVR2 JSM	VR2 Joystick Module with No Actuator Control	D51571

Power Module
D51425, D51426

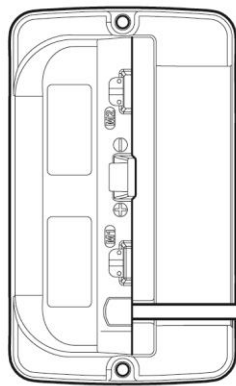

Joystick Module
D51571

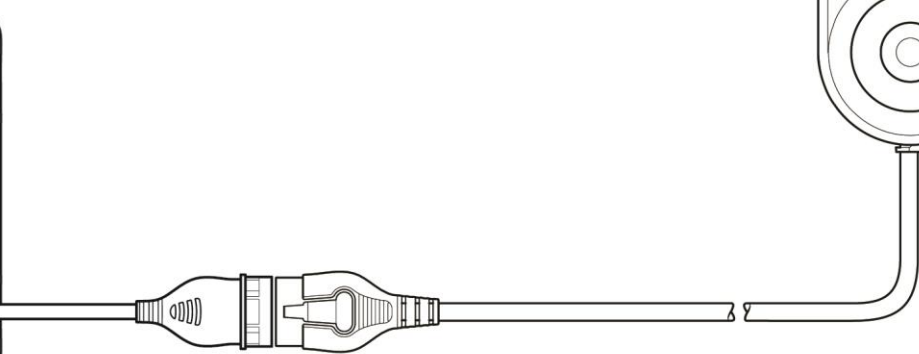
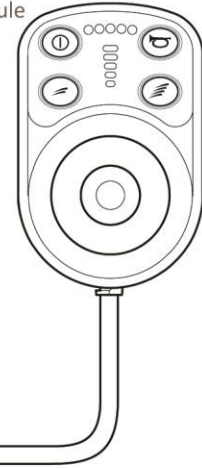

2 CONTROLS

All information regarding handling advice, cleaning requirements and overall control described in Chapter 1 should be followed.

Joystick Module (D51571)

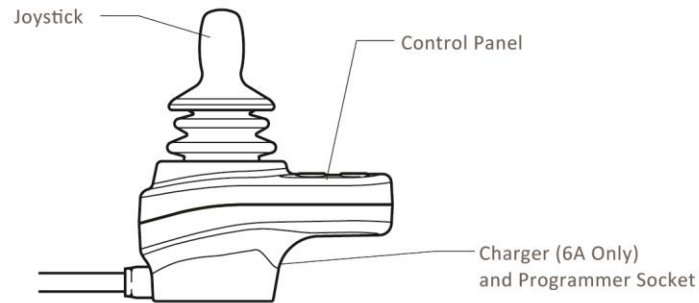

Control Panel

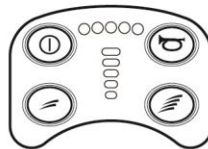

Controls

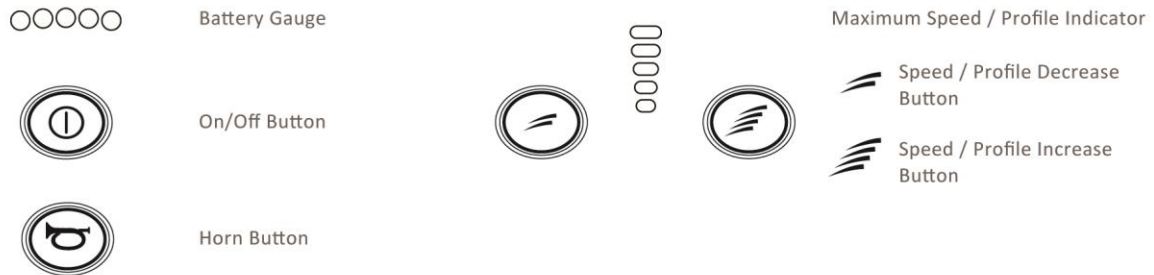

All the controls are common as previously described in Chapter 1 with the exception of the 5 LED battery gauge. See below for details.

2.1 CONTROL SYSTEM STATUS INDICATION

The battery gauge and maximum speed /profile indicator show the status of the controller.



A number of supposedly defective controllers returned to us are subsequently found to operate correctly. This indicates that many reported faults are due to wheelchair problems rather than the controller.



2.1.1 BATTERY GAUGE IS STEADY

This indicates that all is well.

2.1.2 FIRST LED FLASHING SLOWLY

The controller is functioning correctly, but you should charge the battery as soon as possible.

2.1.3 BATTERY GAUGE STEPS UP

The wheelchair batteries are being charged. You will not be able to drive the wheelchair until the charger is disconnected and you have switched the controller off and on again.

2.1.4 ALL 5 LEDS IN THE BATTERY DISPLAY ARE FLASHING

The controller safety circuits have operated and the controller has been prevented from moving the wheelchair.

This indicates a system trip, i.e. the newVSI has detected a problem somewhere in the wheelchair's electrical system. Please follow this procedure:

- Switch off the controller.
- Make sure that all connectors on the wheelchair and the controller are mated securely.
- Check the condition of the battery.
- If you can't find the problem, try using the self-help guide given in section 8.5.
- Switch on the controller again and try to drive the wheelchair. If the safety circuits operate again, switch off and do not try to use the wheelchair.

Contact your service agent.

2.1.5 SELF-HELP GUIDE

If a system trip occurs, you can find out what has happened by counting the number of flashes of the battery gauge.

Below is a list of self-help actions. Try to use this list before you contact your service agent. Go to the number in the list which matches the number of flashes of the battery gauge and follow the instructions.

If the problem persists after you made the checks described above contact your service agent.



If the programmable parameter, Motor Swap has been enabled, then left and right hand references in this table will need transposing.



- 1 Flash** - The battery needs charging or there is a bad connection to the battery. Check the connections to the battery. If the connections are good, try charging the battery.
- 2 Flashes** - The left hand motor has a bad connection. Check the connections to the left hand motor.
- 3 Flashes** - The left hand motor has a short circuit to a battery connection. Contact your service agent.
- 4 Flashes** - The right hand motor has a bad connection. Check the connections to the right hand motor.
- 5 Flashes** - The right hand motor has a short circuit to a battery connection. Contact your service agent.
- 7 Flashes** - A joystick fault is indicated. Make sure that the joystick is in the center position before switching on the controller.
- 8 Flashes** - A controller fault is indicated. Make sure that all connections are secure.
- 9 Flashes** - The parking brakes have a bad connection. Check the parking brake and motor connections. Make sure the controller connections are secure.
- 10 Flashes** - An excessive voltage has been applied to the controller. This is usually caused by a poor battery connection. Check the battery connections.

2.1.6 SLOW OR SLUGGISH MOVEMENT

If the wheelchair does not travel at full speed or does not respond quickly enough, and the battery condition is good, check the maximum speed setting. If adjusting the speed setting does not remedy the problem then there may be a non-hazardous fault.

Contact your service agent

2.2 BATTERY GAUGE

The battery gauge is included to let you know how much charge is left in your batteries. The best way for you to use the gauge is to learn how it behaves as you drive the wheelchair. Like the fuel gauge in a car, it is not completely accurate, but it will help you avoid running out of “fuel”.

The battery gauge works in the following way:

When you switch on the controller, the battery gauge shows an estimate of the remaining battery charge.

The battery gauge gives you a more accurate reading about a minute after you start driving the wheelchair.



When you replace worn out batteries, fit the type recommended by the wheelchair manufacturer. If you use another type the battery gauge may be inaccurate.

The amount of charge in your batteries depends on a number of factors, including the way you use your wheelchair, the temperature of the batteries, their age and the way they are made. These factors will affect the distance you can travel in your wheelchair. All wheelchair batteries will gradually lose their capacity as they age.



The most important factor that reduces the life of your batteries is the amount of charge you take from the batteries before you recharge them. Battery life is also reduced by the number of times you charge and discharge the batteries.

To make your batteries last longer, do not allow them to become completely flat. Always recharge your batteries promptly after they are discharged.

If your battery gauge reading seems to fall more quickly than usual, your batteries may be worn out.

2.2.1 HOW TO READ THE BATTERY GAUGE

If the battery gauge shows red, yellow and green, the batteries are charged.

If the battery gauges show just red and yellow, then you should charge the batteries as soon as you can.

If the battery gauge shows just red, either steady or flashing slowly, then you should charge the batteries immediately.

Do not operate the controller if the battery is nearly discharged. Failure to comply with this condition may leave the user stranded in an unsafe position, such as in the middle of a road. PGDT accepts no liability for losses of any kind arising from failure to comply with this condition.

3 MOUNTING AND INSTALLATION

3.1 JOYSTICK MODULE MOUNTING

The Joystick Module (D51571) dimensions and mounting hole positioning is the same as previously described in Chapter 2.

3.2 POWER MODULE MOUNTING

The Power Modules dimensions are shown in the following diagram. The Modules can, however, be mounted as per the instructions in Chapter 2.

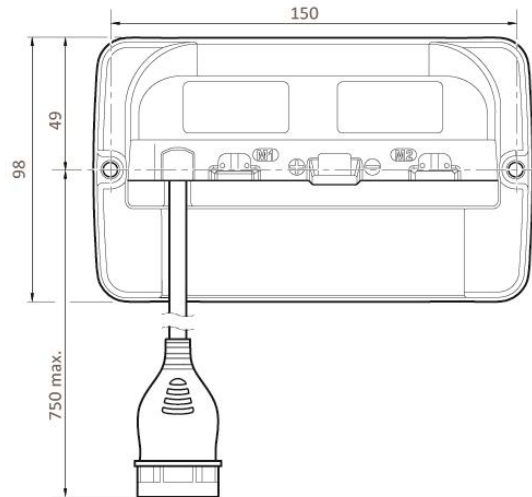

4 POWER MODULE WIRING

4.1 GENERAL

Study the data sheets for the Power Modules (D51425 and D51426) to identify:

- The output current, ratings and restrictions.
- The connector pin assignments.

Make sure that the connectors you use are reliable under all operating conditions and correctly wired with no short circuits. Do not use unsuitable components - it may result in poor wheelchair reliability.



The chair manufacturer is responsible for ensuring that only the mating connectors specified by Penny & Giles Controls Limited on the control systems' specific data sheet are used to connect to the control system. Penny & Giles Controls Limited accepts no liability for losses of any kind arising from failure to comply with this condition.



The chair manufacturer is responsible for ensuring that suitable connectors are used and securely mated throughout the chair wiring system and that the workmanship associated with the wiring system is of a good enough quality. Failure to meet this condition could result in intermittent operation, sudden stopping or veering, or even create a burn or fire hazard. Penny & Giles Controls Limited accepts no liability for losses of any kind arising from failure to comply with this condition.

The information pertaining to connectors, crimps and crimp tool part numbers can be found in Chapter 2.

4.2 POWER MODULE WIRING

The VR2 PM50 and VR2 PM60 Power Module, each include an Inter Connection cable, a battery connector and 2 motor connectors.

The following diagram gives details of the Power Module connections.

VR2 PM 50 & VR2 PM 60
D51425 & D51426

Connection

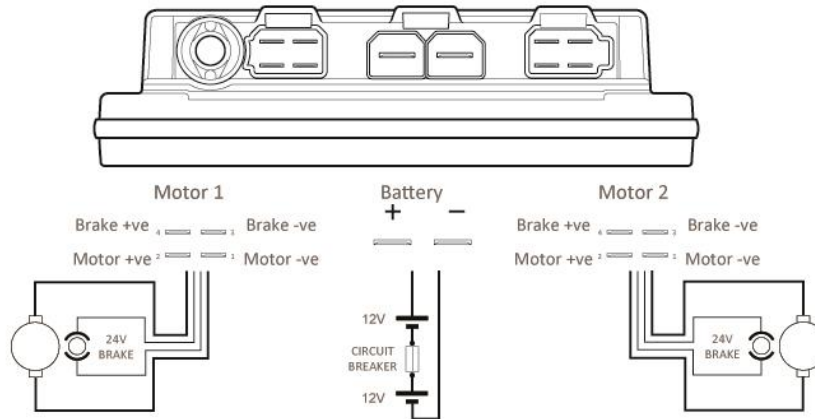

4.3 WIRE GAUGES

The table below gives the minimum recommended wire sizes defined in ISO7176: 2008.

Controller Current Limit (A)	Battery wire size (mm ²)		Motor Wiring size (mm ²)	
	For Length <1000mm	For length 1000mm - 1500mm	For Length <1000mm	For length 1000mm - 1500mm
40	3.0	4.0	2.5	3.0
50	4.0	4.0	3.0	4.0
60	6.0	6.0	3.0	4.0



The chair manufacturer is responsible for establishing the suitability of the particular wiring arrangements used on the wheelchair, for both normal use and stalled conditions. Penny & Giles Controls Limited can make general recommendations for wiring for control systems, but Penny & Giles Controls Limited accepts no responsibility for, and accepts no liability for losses of any kind arising from, the actual wiring arrangement used.



PGDT recommend 0.5mm² PVC for the brake connections. Battery, motor, brake and on-board charger wires should use PVC coated wire rated to UL1569.

4.4 BATTERY WIRING

The control system incorporates sophisticated current limiting circuitry as protection for the circuits in the control system.

ISO 7176-14 requires you to provide protection against short circuits in the battery wiring and the power loom or in the extremely unlikely event of a short circuit in the control system.

Place a suitable circuit breaker in series with the battery supply (refer to section 4.2), for example in the link between two 12V batteries. If your batteries are held in separate enclosures, you must provide a circuit breaker with each of them.



The rating of the circuit breaker must match the capacity of the wiring used. We recommend the use of a 70A circuit breaker for VR2 PM 50 & VR2 PM 60 systems. This recommendation is derived from well proven field experience of various international wheelchair manufacturers. Nevertheless, manufacturers must confirm these recommendations by carrying out suitable tests.

ISO 7176-14 states that the minimum operating time for the circuit breaker when the wheelchair is stalled is 15 seconds.



The chair manufacturer must install a suitable circuit breaker to provide protection against short circuits in the battery wiring, power loom or the control system. Failure to comply with this could result in a fire hazard. Penny & Giles Controls Limited accepts no liability for losses of any kind arising from failure to comply with this condition.

4.5 SOLENOID BRAKES

The control system will be immobilized instantly if the brake current is less than approximately 100mA.

- The maximum continuous current is 1A.



The nVR2 Power Modules are designed to operate with 24V brakes only.

4.6 BATTERY CHARGING

The Modules described in this Chapter support off-board charging only. While the battery is being charged the VR2's TruCharge display will continuously ripple or step upwards.

The maximum permissible charging current is 6A rms. Only chargers fitted with Neutrik NC3MX plugs should be connected into the VR2 control system. The pin connections of the socket are as below.

Pin	Connection
1	Battery Positive
2	Inhibit
3	Battery Negative

To prevent the wheelchair from driving while the charger is connected, pin 3 must be linked to pin 2 inside the charger's plug.



Do not exceed the maximum charging current of 6A rms. Always use an off-board charger fitted with a Neutrik NC3MX plug. Failure to observe these conditions could result in poor contact resistance in the charger connector resulting in overheating of the charger plugs. This presents a potential burn hazard for the user. Penny & Giles Controls Limited accepts no liability for losses of any kind arising from failure to comply with this condition.



Ensure that the charger plug pins are of the correct polarity to be compatible with the pin polarity shown on the control system's specific data sheet. Failure to observe this condition could result in a burn hazard or fire hazard. Penny & Giles Controls Limited accepts no liability for losses of any kind arising from failure to comply with this condition.



Do not disconnect batteries or open-circuit the circuit breaker while charging is in progress. Failure to observe this condition could result in a burns hazard or fire hazard. Penny & Giles Controls Limited accepts no liability for losses of any kind arising from failure to comply with this condition.



CHAPTER 4 - PROGRAMMING

1 INTRODUCTION

This chapter gives an overview of the programmable parameters within the VR2 control system. The VR2 can be programmed with a PP1 Handheld Programmer, DTT or a PG Drives Technology PC Programmer.

This chapter does not give details of how to make adjustments, for these details please refer to the relevant documentation for the programmer you are using.



Programming should only be conducted by healthcare professionals with in-depth knowledge of Penny & Giles Controls Limited control systems. Incorrect programming could result in an unsafe set-up of a wheelchair for a user. Penny & Giles Controls Limited accept no responsibility for losses of any kind if the programming of the control system is altered from the factory pre-set values.

1.1 HAND-HELD PROGRAMMERS

The PP1a and DDT are hand-held units which can be plugged into your controller to alter the controller’s programming. Your wheelchair distributor or service agent or wheelchair manufacturer will be able to program your controller for you.

The PP1a and the DTT handheld programmers are intended to give dealers and therapist access to the programmable parameters which can be used to adjust the wheelchair to an individual user. These parameters are:

Acceleration	Deceleration	Turn Acceleration
Turn Deceleration	Forward Speed	Reverse Speed
Turning Speed	Power	Profiles
Actuator Selection	Actuator 1 End Force	Actuator 2 End Force
Actuator End Stop Bleep	Sleep Timer	Joystick Throw
Invert joystick	Steer Correct	Switch Bleep Volume
Speed Adjustment while Driving	Reverse Driving Alarm	Torque
Tremor Damping		

1.2 PC PROGRAMMER

There are three versions of the PC Programmer – one for dealers and therapists which gives the same access level as the PP1a handheld programmer, one for wheelchair OEM’s which gives access to all standard VR2 control system parameters and one for use by OEM’s on their production lines. These are known as Dealer, OEM and Manufacturing respectively.

For details of how to use these software packages with VR2, refer to the documentation supplied with the software.



1.3 PARAMETERS

The parameters have been separated into workable groups for easy referencing.

Speeds - Section 2

Acceleration
Deceleration
Turn Acceleration
Turn Deceleration
Forward Speed
Reverse Speed
Turning Speed
Power
Number of Drive Profiles
Minimum Acceleration
Minimum Deceleration
Minimum Turn Acceleration
Minimum Turn Deceleration

Actuators - Section 3

Number of Actuators
Actuator 1 End Force
Actuator 1 Current Limit Timeout
Actuator 2 End Force
Actuator 2 Current Limit Timeout
Actuator End stop bleep.
Actuator Selection with Joystick
Invert Actuator Axis 1
Invert Actuator Axis 2

Operation - Section 4

Sleep Timer
Joystick Throw
Invert Joystick
Steer Correct
Switch Bleep Volume
Speed Adjustment while Driving
Service Timer

Battery - Section 5

Low Battery Flash
Cable Resistance
Calibration Factor
Low Battery Alarm
Low Voltage Cut Out
Low Voltage Time

Inhibit – Section 6

Inhibit 2 Threshold Levels
Inhibit 2 Speed Limit Bands
Inhibit 2 Operation
Inhibit 2 Debounce
Seat Reversal
Inhibit 3 Threshold Levels
Inhibit 3 Speed Limit Bands
Inhibit 3 Operation
Inhibit 3 Debounce
Inhibit 1 Alarm
Inhibit 2 Alarm
Inhibit 3 Alarm
Inhibit Actuator Channel 1 Up/Down
Inhibit Actuator Channel 2 Up/Down
Disable Inhibit 2 in Drive
Disable Inhibit 3 in Drive

General – Section 7

Fast Brake rate
Soft Stop
Soft Reverse Deceleration Rate
Reverse Driving Alarm
Brake Disconnect Alarm
K10
Lock Function Enabled
Brake Fault Detect

Brake Voltage
Output Voltage
Front Wheel Drive Type
Front Wheel Drive Rate
FWD Acceleration Limit
Advanced Electronic Stability (AES)
AES Rate

Motor – Section 8

Current Limit Max
Current Foldback Threshold
Current Foldback time
Current Foldback level
Current Foldback Temperature
Current Limit Min
Boost Drive Current
Boost Drive Time
Motor Compensation
Invert M1 Direction
Invert M2 Direction
Motor Swap
Torque
Tremor Damping
Joystick Stationary Time
Joystick Stationary Range
Demand Clipping (R-net)
Turning Torque
Motor Stall Timeout

Memory Functions – Section 9

Read System Log
Clear System Log
Read Timer
Clear Timer

1.4 SAFETY FENCES

Limits (or fences) can be applied to some dealer accessible programmable parameters. These limits are known as safety fences and are programmed by PGDT when the Control System is manufactured. The purpose of these fences is to prevent the wheelchair being programmed to be too fast, or too severe in its acceleration or deceleration. The parameters which can have fences applied to them are:

Forward Speed	Acceleration (forward &reverse combined)
Reverse Speed	Deceleration (forward &reverse combined)
Turning Speed	Turn Acceleration (forward &reverse combined)
Min Power	Turn Deceleration (forward &reverse combined)

Standard PGDT settings are 0 for the minimum fence value and 100 for the maximum fence value, meaning there is a full range of adjustment. If you wish to apply different fence values, please contact PGDT.



Penny & Giles Controls Limited accepts no liability for losses of any kind if the chair manufacturer does not specify appropriate safety fence values for a particular wheelchair application.

1.5 DRIVE PROFILES

The VR2 can operate with single or multiple drive profiles. A drive profile is a collection of programmable parameters comprising of Acceleration, Deceleration, Turn Acceleration, Turn Deceleration, Forward Speed, Reverse Speed and Turning Speed. The number of drive profiles is determined by the programmable parameter, Number of Drive Profiles.

If Number of Drive Profiles is set to 0, then there is one setting for each of the parameters listed previously, and the control system's maximum speed setting can be changed with the maximum speed / profile increase and decrease buttons.

If the value of Number of Drive Profiles is 2 to 5, there is a corresponding number of drive profiles and each listed parameter can be individually set within a profile. The maximum speed /profile increase and decrease buttons are then used to switch between the available profiles.



Although a number of Drive Profiles can be set to one, the operation is the same as setting to 0 but without the ability to change maximum speed settings.



2 SPEED PARAMETERS

2.1 ACCELERATION

Adjusts the value for forward and reverse acceleration of the wheelchair.

Adjustable in steps of 1 from 0 to 100.

A higher value gives faster acceleration. This programmed value of acceleration occurs when speed setting 5 is selected. Its value at other settings depends on the value of the Minimum Acceleration parameter.

2.2 DECELERATION

Adjusts the value for forward and reverse deceleration (or braking) of the wheelchair.

Adjustable in steps of 1 from 0 to 100.

A higher value gives faster deceleration. This programmed value of deceleration occurs when speed setting 5 is selected. Its value at other settings depends on the value of the Min Deceleration parameter.

2.3 TURN ACCELERATION

Adjusts the value for turning acceleration of the wheelchair, from 0 to 100 in steps of 1. A higher value gives faster acceleration. This programmed value of acceleration occurs when speed setting 5 is selected. Its value at other settings depends on the value of the Minimum Turn Acceleration parameter.

2.4 TURN DECELERATION

Adjusts the value for turning deceleration (or braking) of the wheelchair.

Adjustable in steps of 1 from 0 to 100.

A higher value gives faster deceleration. This programmed value of deceleration occurs when the Joystick Module has speed setting 5 selected. Its value at other settings depends on the value of the Minimum Turn Deceleration parameter.

2.5 FORWARD SPEED

Adjusts the minimum and maximum values for forward speed of the wheelchair.

Adjustable in steps of 1% from 0 to 100%.

A higher value gives a faster speed. The minimum value occurs when speed setting 1 is selected, and the maximum value occurs at speed setting 5.



2.6 REVERSE SPEED

Adjusts the minimum and maximum values for reverse speed of the wheelchair.

Adjustable in steps of 1% from 0 to 100%.

A higher value gives a faster speed. The minimum value occurs when the speed setting 1 is selected, and the maximum value occurs at speed setting 5.

2.7 TURNING SPEED

Adjusts the minimum and maximum values for the turning speed of the wheelchair.

Adjustable in steps of 1% from 0 to 100%.

A higher value gives a faster speed. If Drive Profile 0 is selected then the minimum value occurs when speed setting 1 is selected, and the maximum value occurs when speed setting 5 is selected.

2.8 POWER

Sets the power of the wheelchair.

Adjustable in steps of 1% from 0 to 100%.

Power is the ability of a wheelchair to climb a hill or overcome an obstacle. If it is set to 100% then the wheelchair will provide full power. Values below 100% will result in reduced power.

A typical use is to minimize damage to doorways or furniture if the wheelchair is being used indoors. The values can be set independently between drive profiles, meaning separate indoor and outdoor profiles can be defined.

Example: VR2 70 is programmed to:

Current Limit Max.	= 70 Amps
Power (Profile 1)	= 100%
Power (Profile 2)	= 50%

This means that in profile 1 the VR2 will output 70A, but in profile 2 will output 50% of 70A = 35A.

2.9 NUMBER OF DRIVE PROFILES

Refer to section 1.5.



2.10 MINIMUM ACCELERATION

Adjusts the minimum value for forward and reverse acceleration of the wheelchair.

Adjustable in increments of 1% of the Acceleration value.

This percentage of the Acceleration value occurs when the VR2 speed setting is at 1.

See following example.

Acceleration = 80 and Minimum Acceleration = 25%

Acceleration at step 1 = 25% of 80 = 20

Speed settings 2, 3 and 4 will interpolate linearly between 20 and 80

Acceleration at step 2 = 35

Acceleration at step 3 = 50

Acceleration at step 4 = 65

2.11 MINIMUM DECELERATION

Adjusts the minimum value for forward and reverse deceleration of the wheelchair.

Adjustable in increments of 1% of the Deceleration value.

This percentage of the Deceleration value occurs when the VR2 speed setting is at 1.

See following example.

Deceleration = 80 and Minimum Deceleration = 25%

Deceleration at step 1 = 25% of 80 = 20

Speed settings 2, 3 and 4 will interpolate linearly between 20 and 80

Deceleration at step 2 = 35

Deceleration at step 3 = 50

Deceleration at step 4 = 65

2.12 MINIMUM TURN ACCELERATION

Adjusts the minimum value for turning acceleration of the wheelchair.

Adjustable in increments of 1% of the Turn Acceleration value.

This percentage of the Turn Acceleration value occurs when the VR2 speed setting is at 1.

See following example.

Turn Acceleration = 80 and Minimum Turn Acceleration = 25%

Turn Acceleration at step 1 = 25% of 80 = 20

Speed settings 2, 3 and 4 will interpolate linearly between 20 and 80

Turn Acceleration at step 2 = 35



Turn Acceleration at step 3 = 50

Turn Acceleration at step 4 = 65

2.13 MINIMUM TURN DECELERATION

Adjusts the minimum value for turning deceleration of the wheelchair.

Adjustable in increments of 1% of the Turn Deceleration value.

This percentage of the Turn Deceleration value occurs when the VR2 speed setting is at 1.

See following example.

Turn Deceleration = 80 and Minimum Turn Deceleration = 25%

Turn Deceleration at step 1 = 25% of 80 = 20

Speed settings 2, 3 and 4 will interpolate linearly between 20 and 80

Turn Deceleration at step 2 = 35

Turn Deceleration at step 3 = 50

Turn Deceleration at step 4 = 65

3 ACTUATOR PARAMETERS

3.1 NUMBER OF ACTUATORS

Set's the number of actuators to be connected to the VR2 control system. This value must be set correctly in order to get the most informative and user-friendly method of actuator control.

It is adjustable between 0 - 2 actuators in steps of 1.

3.2 ACTUATOR 1 END FORCE

Adjusts the operating force of actuator channel 1. The reason this is programmable is to provide an automatic shut-off of an actuator motor at the end position.

The value is adjustable between 1 and 5. A higher value gives a higher force. The value should be chosen so that the actuator can move under its heaviest load condition, but will shut-off automatically when stalled at the end stop

3.3 ACTUATOR 1 CURRENT LIMIT TIME OUT

This adjusts the length of time the control system will apply current to the actuator motor once it has reached its End Force current limit. It is adjustable between 50ms and 500ms in steps of 10ms.



3.4 ACTUATOR 2 END FORCE

Adjusts the operating force of actuator channel 2. The reason this is programmable is to provide an automatic shut-off of an actuator motor at the end position.

The value is adjustable between 1 and 5. A higher value gives a higher force. The value should be chosen so that the actuator can move under its heaviest load condition, but will shut-off automatically when stalled at the end stop.

3.5 ACTUATOR 2 CURRENT LIMIT TIME OUT

This adjusts the length of time the control system will apply current to the actuator motor once it has reached its End Force current limit.

It is adjustable between 50ms and 500ms in steps of 10ms.

3.6 ACTUATOR SELECTION WITH JOYSTICK

This parameter determines whether selection between different actuator channels can be made with left/right movements of the joystick. You can set between on and off.

On Means that selection between actuator channels can be made with the joystick and the actuator buttons.

Off Means that only the actuator buttons can be used to select between actuator channels.

The parameter is only applicable if the Number of Actuators parameter is set to greater than 1.

3.7 ACTUATOR END STOP DETECTION

This can protect the actuator motor from high levels of current over extended periods of time.

This parameter can be set to On or Off.

On The parameters Actuator End Force and Actuator Current Limit Time Out are activated and stop the actuator motors.

Off The actuator will not be automatically stopped by the control system.

3.8 ACTUATOR END STOP BLEEP

This allows the use of an Audible bleep to tell you when the Actuator is stalled at its end stop.



3.9 INVERT ACTUATOR AXIS 1

This parameter reverses the polarity of Actuator channel 1.

Invert Axis 1	Joystick	Pin 1	Pin 2
YES	Forward	Positive	Negative
YES	Reverse	Negative	Positive
NO	Forward	Negative	Positive
NO	Reverse	Positive	Negative

This parameter can be set to On or Off.

3.10 INVERT ACTUATOR AXIS 2

This parameter reverses the polarity of Actuator channel 1.

Invert Axis 2	Joystick	Pin 1	Pin 2
YES	Forward	Positive	Negative
YES	Reverse	Negative	Positive
NO	Forward	Negative	Positive
NO	Reverse	Positive	Negative

This parameter can be set to On or Off.

4 OPERATION PARAMETERS

4.1 SLEEP TIMER

Sets the period of time before the control system will turn itself off if the wheelchair is not driven.

The time can be set between 0 and 30 minutes in steps of 1 minute.

If the time is set to 0 the system will never turn itself off.

4.2 JOYSTICK THROW

This allows you to program the control system so that full speed can be reached with a reduced joystick movement (throw). This is particularly useful for wheelchair users with limited hand or arm movement.



4.3 INVERT JOYSTICK

This parameter inverts the direction of travel when moving the joystick.

This parameter can be set to On or Off.

On Deflecting the joystick Forward will result in Reverse drive.

Off Deflecting the joystick Forward will result in Forward drive.



Left and Right deflection of the joystick remain unchanged.

4.4 STEER CORRECT

This parameter compensates for any mismatching of motors to ensure that the wheelchair drives directly forward when the control system's joystick is being pushed directly forward.

It is normally set to zero but may be varied from -9 to +9 in increments of 1. If the chair is veering to the left, you should increase the setting. If the chair veers to the right, decrease the setting. If Swap Motors is set, this logic will be reversed.

4.5 SWITCH BLEEP VOLUME

Switch Bleep Volume sets the volume of the audible feedback given whenever a button on the VR2 is operated.

Adjustable between 0 and 10 in steps of 1.

If the parameter is set to 0 then the Switch Bleep function is effectively switched OFF.

The higher the value, the louder the audible feedback.

4.6 SPEED ADJUSTMENT WHILE DRIVING

This parameter sets whether the VR2's speed/profile buttons are active while the wheelchair is being driven. The parameter can be set to on or off.

On Means the buttons are active while the wheelchair is being driven, so the user can make maximum speed setting adjustments (or select a different drive profile) while actually moving.

Off Means the buttons are not active while the wheelchair is being driven, so the joystick must be released and the wheelchair at rest before maximum speed setting adjustments (or different drive profile selections) can be made.

4.7 SERVICE TIMER



nVR2 PM50 & nVR2 PM 60 Only

The service timer function is used to set the number of hours that need to elapse before the controller notifies the user that a new service is required.

The service timer can be programmed between 0hrs (off) and 10000 hours in steps of 10 hours.

When the service timer is active the TruCharge display will flash 900ms on, 100ms second off, for the first 20 seconds after the controller is switched On. The service reminder is reset by incrementing the Service Timer in the PC Programmer.



Active diagnostic display's will always take precedence over the Service Reminder

5 BATTERY PARAMETERS

5.1 LOW BATTERY FLASH LEVEL

This parameter sets the point at which the VR2's TruCharge battery gauge starts to flash slowly to warn of a low battery condition.

Adjustable between 0 and 10 in steps of 1.

This corresponds to the number of bars shown on the battery gauge.

For example, if this value is set to 2, then the flashing will occur when the gauge drops to 2 bars.

5.2 CABLE RESISTANCE

This parameter should be set to the total value of the electrical resistance of wires between the batteries and the VR2 body. This parameter ensures the TruCharge battery gauge gives an accurate reading under all driving conditions.

Adjustable between 0 and 255m Ω in steps of 1m Ω .

The value should take into account the electrical resistance in both the positive and negative connections.

The battery wires in the VR2 cable have a typical electrical resistance of 4.6m Ω /metre. Therefore, if the VR2 has a 1.3m cable, the Cable Resistance setting must be at least: $(1.3 \times 4.6\text{m}\Omega) \times 2 = 12\text{m}\Omega$.

To this value you must also add the resistance of the wheelchair wiring between the batteries and the VR2 connectors.



5.3 CALIBRATION FACTOR

This allows further fine calibration of the TruCharge battery gauge.

This is normally set at the factory and should not need further adjustment.

5.4 LOW BATTERY ALARM

This parameter sets whether the VR2 will give an audible alarm to signal a low battery condition. The point at which the alarm will sound corresponds to the Low Battery Flash Level setting. The parameter can be set to On or Off.

On Means an alarm will sound.

Off Means there will be no alarm.

5.5 LOW VOLTAGE CUT OUT.

This allows programming of the level the voltage must reach for the period set by Low Voltage Time before the control system ceases to operate.

It is programmable from 16V to 22V in steps of 0.5V.

5.6 LOW VOLTAGE TIME

This allows programming of the length of time the voltage must be below the Low Voltage Cut Out Level before the control system ceases to operate.

Programmable from 1 to 255 seconds in steps of 1 second.

6 INHIBIT PARAMETERS

The VR2 contains two highly versatile inhibit inputs that can be configured to provide drive inhibit, speed limiting and actuator inhibit functions. These inputs are referred to as Inhibit 2 and Inhibit 3.

Inhibit 2 is via a dedicated 2-way connector on the Power Module.

Inhibit 3 is via pin 3 of the On-board Charger connector on the Power Module.

6.1 INHIBIT 2 THRESHOLD LEVEL

Inhibit 2 has 4 possible input states, known as bands. Each band corresponds to a range of electrical resistance connected to the input. The range or size of each band is programmable, via three parameters, Inhibit 2 Lower Level Threshold, Inhibit 2 Middle Level Threshold and Inhibit 2 Upper Level Threshold.

The following diagram shows the concept.

Threshold - Band Relationship

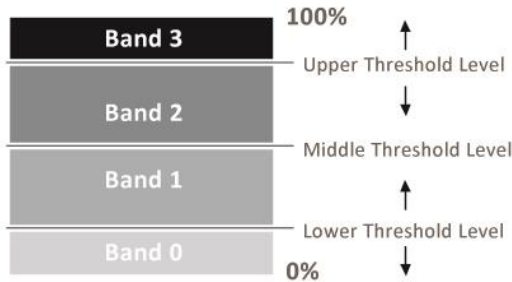

100% corresponds to a resistance of 10KOhm or greater, including an open-circuit on pin 2 of Inhibit 2.

0% corresponds to a short circuit between pins 1 and 2 of Inhibit 2.

Each of the Level Threshold parameters can be set to a value of 0% to 100% in steps of 1% meaning the range of each band is programmable. This allows for versatile programming of drive inhibit, speed limit and actuator inhibit conditions from just one input.

For details of drive inhibit and speed limit programming, refer to section 6.2.

For details of actuator inhibit programming refer to section 6.12

6.2 INHIBIT 2 SPEED LIMIT IN BAND X

This section must be read in conjunction with section 6.1.

There are 4 parameters that can be set:

Inhibit 2 Speed Limit in Band 0

Inhibit 2 Speed Limit in Band 1

Inhibit 2 Speed Limit in Band 2

Inhibit 2 Speed Limit in Band 3

Each is programmable between 0% and 100% in steps of 1%.

The value in each band's parameter sets the wheelchair's maximum driving speed when the VR2's Inhibit 2 input is in that band.

For example, if Inhibit 2 Speed Limit in Band 3 is set to 0%, then the drive will be fully inhibited when the connection to Inhibit 2 is of a resistance within the range of Band 3.

For a detailed example of actuator inhibits, refer to section 6.15.2.



6.3 INHIBIT 2 OPERATION

This parameter is only relevant if one of the Inhibit 2 Speed Limit in Band x values is set to 0%, i.e. a drive inhibit. The parameter can be set to Latching or Non-latching.

If set to Latching, remove the inhibit, then the VR2 must be switched off and on again to resume drive after an inhibit condition has occurred.

If set to Non-latching, then drive will be possible as soon as the inhibit condition is removed.

If Inhibit 2 is set to latching, then the TruCharge battery gauge will flash 6 bars to indicate a trip. See Chapter 1 section 8.3.

6.4 INHIBIT 2 DEBOUNCE

This parameter sets the amount of time a connection to Inhibit 2 input must be stable before it is interpreted as a valid condition. This parameter is particularly useful for switch types that exhibit “bounce”, such as mercury switches, which are often used on tilt mechanisms.

The parameter is programmable between 100ms and 4000ms in steps 100ms.

6.5 SEAT REVERSAL

The input Inhibit 2 can be configured to provide a seat reversal function. Seat reversal is used on wheelchair models which can be converted from rear wheel drive to front wheel drive by rotating the seat through 180°. The parameter for adjustment is Seat Reversal, the effect of this parameter is explained below.

Seat Reversal can be set to On or Off.

ON Connecting the Inhibit 2 input to 0V will reverse the motors’ forward direction. Motor direction and axes changes as normal and the Front Wheel Drive Rate function is used.

OFF Seat Reversal has no effect.

6.6 INHIBIT 3 THRESHOLD LEVEL

Inhibit 3 has 4 possible input states, known as bands. Each band corresponds to a range of electrical resistance connected to the input. The range or size of each band is programmable, via three parameters, Inhibit 3 Lower Level Threshold, Inhibit 3 Middle Level Threshold and Inhibit 3 Upper Level Threshold.

The diagram in section 6.1 shows the concept.

100% corresponds to a resistance of 10KOhm or greater, including an open-circuit on pin 2 of Inhibit 3.

0% corresponds to a short-circuit between pins 2 and 3 of Inhibit 3.



Each of the Level Threshold parameters can be set to a value of 0% to 100% in steps of 1% meaning the range of each band is programmable. This allows for versatile programming of drive inhibit, speed limit and actuator inhibit conditions from just one input.

For details of drive inhibit and speed limit programming, refer to section 6.7.

For details of actuator inhibit programming refer to section 6.13

6.7 INHIBIT 3 SPEED LIMIT IN BAND X

This section must be read in conjunction with section 6.6.

There are 4 parameters that can be set:

Inhibit 3 Speed Limit in Band 0

Inhibit 3 Speed Limit in Band 1

Inhibit 3 Speed Limit in Band 2

Inhibit 3 Speed Limit in Band 3

Each is programmable between 0% and 100% in steps of 1%.

The value in each band's parameter sets the wheelchair's maximum driving speed when the VR2's Inhibit 3 input is in that band.

For example, if Inhibit 3 Speed Limit in Band 3 is set to 0%, then the drive will be fully inhibited when the connection to Inhibit 3 is of a resistance within the range of Band 3.

For a detailed example of drive inhibits and speed limits, refer to section 6.15.1.

6.8 INHIBIT 3 OPERATION

This parameter is only relevant if one of the Inhibit 3 Speed Limit in Band x values is set to 0%, i.e. a drive inhibit. The parameter can be set to Latching or Non-latching.

If set to Latching, remove the inhibit, then the VR2 must be switched off and on again to resume drive after an inhibit condition has occurred.

If set to Non-latching, then drive will be possible as soon as the inhibit condition is removed.

If Inhibit 3 is set to latching, then the TruCharge battery gauge will indicate the wheelchair is charging when the inhibit is active. See Chapter 1 section 8.3.

6.9 INHIBIT 3 DEBOUNCE

This parameter sets the amount of time a connection to Inhibit 3 input must be stable before it is interpreted as a valid condition. This parameter is particularly useful for switch types that exhibit "bounce", such as mercury switches, which are often used on tilt mechanisms.

The parameter is programmable between 100ms and 4000ms in steps 100ms.



6.10 INHIBIT 1: ALARM

This parameter sets whether there is an audible alarm given when VR2 Inhibit 1 is active. Inhibit 1 is the inhibit associated with the off-board charging socket on the front face of the VR2. The parameter can be set to on or off.

On Means an audible alarm will sound when Inhibit 1 is active.

Off Means there will be no alarm.

6.11 INHIBIT 2: ALARM

This parameter sets whether there is an audible alarm given if VR2 Inhibit 2 is active. Inhibit 2 is normally the inhibit associated with the actuator functions of the VR2. The parameter can be set to on or off.

On Means an audible alarm will sound when Inhibit 2 is active.

Off Means there will be no alarm.

6.12 INHIBIT 3: ALARM

This parameter sets whether there is an audible alarm given if VR2 Inhibit 3 is active. Inhibit 3 is normally the inhibit function associated with the on-board charger connections of the VR2. The parameter can be set to on or off.

On Means an audible alarm will sound when Inhibit 3 is active.

Off Means there will be no alarm.

6.13 ACTUATOR CHANNEL 1 UP INHIBIT AND ACTUATOR CHANNEL 1 DOWN INHIBIT

This section must be read in conjunction with section 6.1. Note Band 1 and Band 2 have no effect on actuator inhibits.

These parameters allow Actuator Channel 1 to be inhibited, in either or both directions, via, either or both, the Inhibit 2 and/or Inhibit 3 inputs.

There are a total of 8 parameters that can be set:

Actuator Channel 1 Up:

Inhibit in Inhibit 2 Band 0
Inhibit in Inhibit 3 Band 0

Inhibit in Inhibit 2 Band 3
Inhibit in Inhibit 3 Band 3

Actuator Channel 1 Down:

Inhibit in Inhibit 2 Band 0
Inhibit in Inhibit 3 Band 0

Inhibit in Inhibit 2 Band 3
Inhibit in Inhibit 3 Band 3

Each parameter can be set to yes or no.



Yes Means that particular actuator channel direction of movement will be inhibited when the relevant inhibit input is in that band.

For example, If Actuator Channel 1 Up: Inhibit in Inhibit 2 Band 3 is set to yes, then Actuator Channel 1 Up direction will be inhibited when the connection to Inhibit 2 is of a resistance within the range of Band 3.

No Means that particular actuator channel direction of movement will not be affected by the relevant inhibit/band combination.

For a more detailed example of actuator inhibits, refer to section 6.15.2.

6.14 ACTUATOR CHANNEL 2 UP INHIBIT AND ACTUATOR CHANNEL 2 DOWN INHIBIT

This parameter operates in the same way as Actuator Channel 1 Up Inhibit and Actuator Channel 1 Down Inhibit, as described in section 6.13.

6.15 INHIBIT EXAMPLES

6.15.1 SPEED INHIBIT EXAMPLES

Application: A wheelchair is fitted with an elevating seat. As the seat raises, the maximum speed is reduced to 50%, then 25% and a full drive inhibit occurs at maximum height.

A circuit such as follows is used.

Actuator Inhibit Possible Switch Set-up

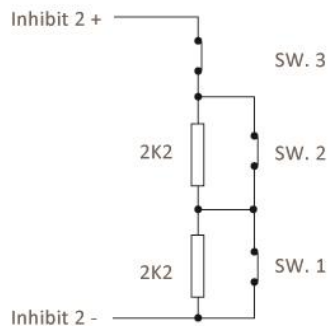

When the seat is in the fully lowered position, all switches are closed and the electrical resistance is a short-circuit or 0 Ohms. As the seat raises, SW1 opens giving 2.2KOhms, then SW2 opens giving 4.4KOhms and at full height SW3 opens giving a complete open-circuit

Programming would be as below.

Inhibit 2 Threshold Levels:

Upper Level Threshold	54%
Middle Level Threshold	34%



Lower Level Threshold 12%

This gives a band arrangement as follows.

Inhibit Bands

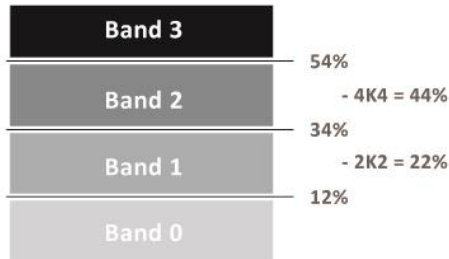

As good practice, the threshold limits have been chosen so the actual resistance values that trigger a change are in the approximate center of the bands, thereby eliminating the risk of a system erroneously switching between bands.

The 4 Speed Limits for Inhibit 2 would need to be set as below:

Inhibit 2:

Speed Limit in Band 0	100%	Speed Limit in Band 1	50%
Speed Limit in Band 2	25%	Speed Limit in Band 3	0%

6.15.2 ACTUATOR INHIBIT EXAMPLES

Application 1:

In an identical fashion to the previous example, a wheelchair is fitted with a lifting seat and as the seat raises the maximum speed is reduced to 50%, then 25% and a full drive inhibit occurs at maximum height. Additionally, it is required to completely inhibit the tilt function at maximum lift height. The VR2 is connected so that Actuator Channel 1 drives the lift motor and Actuator Channel 2 drives the tilt motor.

An identical circuit to that of the previous example could be used.

Programming for the Inhibit 2 Threshold Levels and Inhibit 2 Speed Limit in Band x parameters would also be identical to the previous identical

As it is the tilt motor, which is connected to Actuator Channel 2, the Actuator Channel 2 Up Inhibit and Actuator Channel 2 Down Inhibit parameters would need to be programmed as follows.

Actuator Channel 2 Up:

Inhibit in Inhibit 2 Band 0	no	Inhibit in Inhibit 2 Band 3	yes
Inhibit in Inhibit 3 Band 0	no	Inhibit in Inhibit 3 Band 3	no

Actuator Channel 2 Down:

Inhibit in Inhibit 2 Band 0	no	Inhibit in Inhibit 2 Band 3	yes
-----------------------------	----	-----------------------------	-----



Inhibit in Inhibit 3 Band 0 no

Inhibit in Inhibit 3 Band 3 no

Both Actuator Channel 2 (Tilt) Up and Down directions will be inhibited when the seat is fully raised, i.e. Inhibit 2 input in Band 3.

Application 2:

A wheelchair is fitted with a reclining seat. It is required to offer a programmable angle of recline to suit different users. A potentiometer of maximum value 10KOhm is fitted to the recline mechanism and is connected to the VR2’s Inhibit 2 input. The recline motor is driven by the Actuator Channel 1 output.

By programming the Actuator Channel 1 Up Inhibit and Actuator Channel 1 Down Inhibit parameters as below, it is possible to program the maximum angle of travel of the recline mechanism via the Inhibit 2 Threshold Level parameters.

Actuator Channel 1 Up:

Inhibit in Inhibit 2 Band 0 no
Inhibit in Inhibit 3 Band 0 no

Inhibit in Inhibit 2 Band 3 yes
Inhibit in Inhibit 3 Band 3 no

Actuator Channel 1 Down:

Inhibit in Inhibit 2 Band 0 no
Inhibit in Inhibit 3 Band 0 no

Inhibit in Inhibit 2 Band 3 yes
Inhibit in Inhibit 3 Band 3 no

Threshold - Band Relationship



This programming means that the Up movement will be inhibited when the Inhibit 2 input in Band 0, i.e. one end of recline travel, and that the Down movement will be inhibited when the Inhibit 2 input is in Band 3, i.e. the other end of the recline travel. Referring the Band diagram below, it can be seen that by programming Inhibit 2 Upper Level Threshold and Inhibit 2 Lower Level Threshold, then the actual angular range of the recline mechanism is adjusted.

Note: Bands 1 and 2 are never used in actuator inhibits, so to give maximum adjustment range in this example, then Inhibit 2 Middle Level Threshold is set to 50%.

6.16 DISABLE INHIBIT 2 IN DRIVE

This sets whether the PM Inhibit input is interrogated just at entry into Drive or constantly during Drive.

The programmable options are Yes and No.



If set to Yes, the input will only be interrogated at entry into Drive. An example of when this function may be useful is if a tilt-sensor is used that could be inadvertently operated when driving over rough terrain. By employing this function, an inhibit will only be applied if Drive is entered with the seat in a genuinely tilted position.

If set to No, the input will be interrogated constantly during Drive, i.e. normal inhibit operation.

6.17 DISABLE INHIBIT 3 IN DRIVE

This sets whether the PM Inhibit input is interrogated just at entry into Drive or constantly during Drive.

The programmable options are Yes and No.

If set to Yes, the input will only be interrogated at entry into Drive. An example of when this function may be useful is if a tilt-sensor is used that could be inadvertently operated when driving over rough terrain. By employing this function, an inhibit will only be applied if Drive is entered with the seat in a genuinely tilted position.

If set to No, the input will be interrogated constantly during Drive, i.e. normal inhibit operation.

7 GENERAL PARAMETERS

7.1 FAST BRAKE RATE

Adjusts the deceleration rate used while fast braking. Fast braking is when the joystick is pulled to the reverse position to make a faster stop.

Adjustable between 0 and 200 in steps of 1.

If this value is set lower than the Deceleration value, then the Deceleration value will be used for fast braking.

7.2 SOFT STOP RATE

Adjusts the deceleration rate that is used while the wheelchair is soft-stopping. Soft-stopping happens if the VR2 is switched off while the wheelchair is being driven.

Adjustable between 0 and 200 in steps of 1.

7.3 SOFT REVERSE DECELERATION

Adjusts the deceleration rate used while the wheelchair is stopping in reverse. This rate is separately adjustable from the Deceleration parameter, to prevent the wheelchair tipping when reversing down a gradient.

The value is adjustable from 25 to 100% in steps of 1%. The value is a percentage of the Deceleration parameter. A typical value is 70%.



7.4 SOFT REVERSE DECELERATION

Adjusts the deceleration rate used while the wheelchair is stopping in reverse. This rate is separately adjustable from the Deceleration parameter, to prevent the wheelchair tipping when reversing down a gradient.

Adjustable between 25 to 100% in steps of 1%.

The value is a percentage of the Deceleration parameter.

A typical value is 70%.

7.5 REVERSE DRIVING ALARM

Sets whether the VR2 gives an audible warning while driving in reverse. The parameter can be set to on or off.

On Means there is an audible alarm given.

Off Means there is not.

7.6 BRAKE DISCONNECTED ALARM

Sets whether the VR2 gives an audible warning while the wheelchairs electrical brakes are disconnected. The parameter can be set to on or off.

On Means there is an audible alarm given.

Off Means there is not.

7.7 K10 PROGRAMMING RESTRICTION

Sets whether the VR2 is field programmable or not. The parameter can be set to on or off.

On Means the VR2 cannot be programmed with dealer access programmers, such as a PP1a or PC Programmer.

Off Means the VR2 can be programmed with these types of devices.

7.8 LOCK FUNCTION ENABLED

Sets whether the VR2's locking sequence can be used to prevent the wheelchair being driven by unauthorized persons. The parameter can be set to on or off.

On Means the Lock function is available.

Off Means it is not.

7.9 BRAKE FAULT DETECT

Sets whether the VR2-Detects a fault in the wheelchair's electrical brakes or the connections to them. The parameter can be set to on or off.

On Means the VR2 will detect brake faults.

Off Means the VR2 will not detect brake faults.



This parameter should only ever be set to off if there are no electrical brakes fitted to the wheelchair.

7.10 BRAKE VOLTAGE

This sets the voltage output from the power module to the solenoid brake, it can be programmed to 12V or 24V brakes.



It is essential that the control system is programmed to the correct brake voltage, or damage may be done to the control system, the brakes or the drive performance of the wheelchair.

7.11 OUTPUT VOLTAGE

This sets the value of voltage applied to the motor when the joystick is fully deflected and the relevant speed, forward or reverse, is set to 100%. This feature allows you to choose a motor voltage value such that the wheelchair's top speed will remain constant all the time the battery voltage is above that value.

This value can be set between 20 and 25V in steps of 0.5V.

7.12 FRONT WHEEL DRIVE TYPE



nVR2 PM50 & nVR2 PM 60 and VR2 PM90 only

If Front Wheel Drive Type A, this parameter electronically alters the shape of the joystick gate. This has the effect of damping the turning rate of the wheelchair between the 9 o'clock and 3 o'clock joystick positions.

If Front Wheel Drive Type is set to B, this parameter sets threshold which, if exceeded, then both forward and turn speeds are reduced, but the turning radius of the wheelchair remains unchanged. Type B can be used to increase the steerability of the wheelchair at speed.

7.13 FRONT WHEEL DRIVE RATE



nVR2 PM50 & nVR2 PM 60 and VR2 PM90 only

Adjusts the operation of the specialist software for Front Wheel Drive Wheelchairs.

The programmable range is 0% to 100%. If set to 0%, then conventional rear wheel drive control is always applied. The higher the value selected the more pronounced the impact of either front wheel drive algorithm. A higher value may be suitable for faster front wheel drive wheelchairs.



7.14 FWD ACCELERATION LIMIT



nVR2 PM50 & nVR2 PM 60 and VR2 PM90 only

This limits the forward acceleration of the wheelchair when straightening out of a turn and helps prevent loss of traction.

The programmable range is 0% to 100%.

7.15 ADVANCED ELECTRONIC STABILITY (AES)



nVR2 PM50 & nVR2 PM 60 and VR2 PM90 only

If set to On, AES detects if one wheel is running at a higher load and hence is running more slowly. If so, the speed of the other wheel is reduced accordingly to compensate for any steering offset.

AES can be used to minimise front wheel drive spins, fish-tailing and veering, both on the level and on a camber. The overall effect is to compensate for the wheelchair's centre-of-gravity being shifted from the axis of the drive wheels, as is the case on front wheel drive chairs.

If set Off, then the function is disabled.

7.16 AES RATE



nVR2 PM50 & nVR2 PM 60 and VR2 PM90 only

This sets the rate of adjustment between the wheels under uneven loads. The recommended value is 55% and should not be adjusted without consulting PGDT. A lower value will increase the strength of AES, which could result in the wheelchair feeling "twitchy" on turns. The overall programmable range is 40% to 100%.



8 MOTOR PARAMETERS

8.1 CURRENT LIMIT MAX., CURRENT LIMIT MIN., CURRENT FOLDBACK - THRESHOLD, TIME, LEVEL, & TEMPERATURE BOOST CURRENT & TIME

These parameters affect the VR2's current output with relationships to time and internal VR2 temperature.

The parameters associated with the Motors are:

Current Limit Max.

This is the current the VR2 can deliver until the programmed value of Current Foldback Temperature is reached.

Programmable between 20A and the Control System's Maximum in steps of 1 Amp

Current Limit Min.

This is the current the VR2 will deliver at 80°C internal temperature.

Programmable between 20 and Current Limit Max in steps of 1 Amp

Current Foldback Threshold

This parameter sets the level of current which when exceeded activates the Current Foldback Time parameter.

Programmable between 20 and the Current Limit Max in steps of 1 Amp

Current Foldback Time

This parameter sets the maximum time the control system can be at its current Foldback Threshold before the control system begins to reduce the available current.

Programmable between 0 and 250 in steps of 1 Second

Current Foldback Level

This parameter sets the percentage of current foldback when the control system is at the Current Foldback Threshold for a period greater than current Foldback Time. The value is a percentage of the programmed Current Limit Max.

Programmable between 25 and 100 in steps of 1%.

Boost Drive Current

This is the current the VR2 can deliver for the period of time set by Boost Drive Time.

Programmable between 20A and the control system's maximum in steps of 1 Amp.

Boost Drive Time

This is the length of time that the VR2 can deliver the Boost Drive Current for.



Programmable between 0 and 10 in steps of 1 Second.

Current Foldback Temp.

This parameter sets the temperature within the control system at which the current starts to reduce linearly.

Programmable between 25 and 70 in steps of 1 Degrees C



It is important that the maximum values stated in the table VR2 Current Management are not exceeded.

Example 1- Time / Threshold / Level:

The parameters Threshold, Time and Level can be used to protect the motors from overheating. If the motor current exceeds the value set by Threshold for a period set by Time, then the VR2's current output will be reduced to a value set by Level.

After a fixed reset period of 5 x Current Foldback Time, the current output will be allowed to return to the full current, if demanded. This reset period is to allow the motor(s) sufficient time to cool. As shown by the diagram that follows.

Current Foldback Description

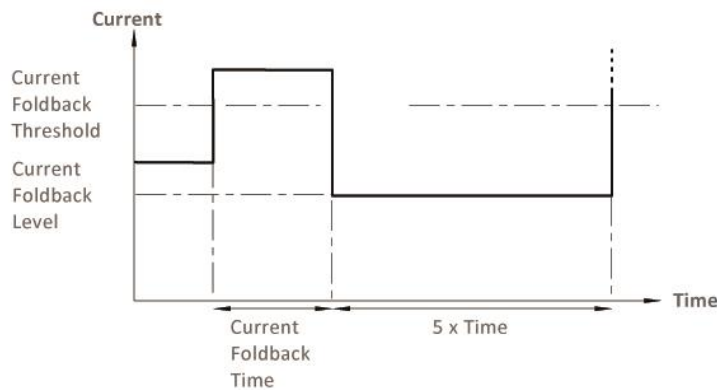

Settings: VR2 is programmed to:

Current Limit Max. = 60 Amps
Current Foldback Threshold = 60 Amps
Current Foldback Time = 15 Seconds
Current Foldback Level = 25%

This is useful for protecting motors against potential damage when the wheelchair is being used on a long gradient. After 15 seconds the current output of the VR2 will reduce to 25% of 60A = 15A. After 5 x 15s = 75s, the current output will return to 60A.

If no timed foldback is required, simply set Current Foldback Level to 100%.

Example 2 - Temperature:

The VR2 protects itself by measuring its internal temperature. When this temperature reaches a certain level the current output starts to reduce. This relationship is shown in the following illustration.

1 - Current Foldback Threshold.



This is the current the VR2 can deliver until the programmed value of Current Foldback Temperature is reached.

2- Current Limit Min.

This is the current the VR2 will deliver at 80°C internal temperature.

3 - Current Foldback Temp.

This parameter sets the temperature within the control system at which the current starts to reduce linearly.

Current/Temperature Relationship

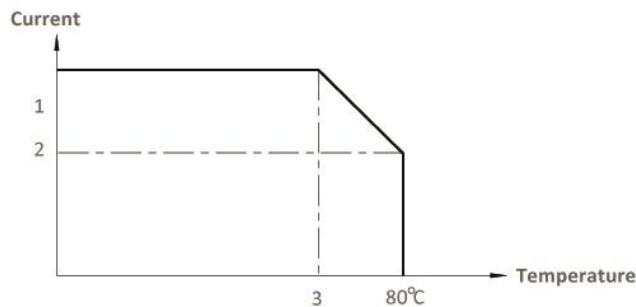

It is important that the maximum values in the table shown below are not exceeded for the VR2 model you are working with.



The values in the table above should never be exceeded. Doing so will invalidate the warranty and affect the long term reliability of the control system.

Example 3 - Boost - VR2(90) ONLY

The parameters Boost Drive Current and Boost Drive Time provide a current boost for a set period of time on demand. Such as when the wheelchair is being driven up an incline.

Current/Time Relationship

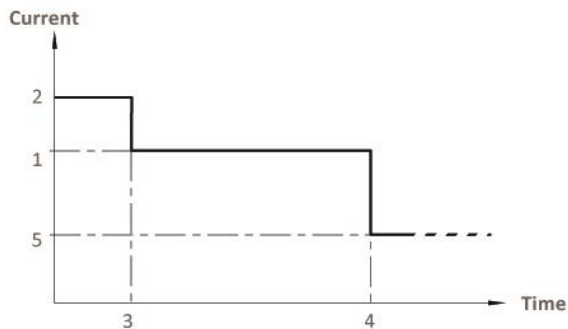

1 - Current Limit Max.

This is the current the VR2 can deliver until the programmed value of Current Foldback Temperature is reached.

2 - Boost Drive Current



This is the current the VR2 can deliver for the time defined by Boost Drive Time

3 - Boost Drive Time

This is the time for which the VR2 can deliver the current by Boost Drive Current.

4 - Current Foldback Time

This sets the time for which VR2 will deliver the current defined by Current Limit Max.

5 - Current Foldback Level

This parameter sets the percentage of current foldback when the control system is at the Current Foldback Threshold.

8.2 MOTOR COMPENSATION

This matches the VR2 to suit different motor types in order to achieve optimal performance and drive control. This value should be set in accordance with the armature resistance of the motor and all cables and connectors between the VR2 and the motor. The value is set in milli-Ohms ($m\Omega$). A recommended value is:

- 70% of the (armature resistance + cables and connectors)

Motor manufacturers should be able to supply figures for armature resistance and cable and connectors may typically be $40m\Omega$.

Example: Motor has armature resistance of $200m\Omega$

Cables and connectors are $40m\Omega$

Set Motor Compensation to $0.7 \times (200 + 40) = 170m\Omega$



Never exceed the 70% relationship described above.



The chair manufacturer is responsible for ensuring that the control system is matched to the motor resistance. Failure to do this may result in poor control characteristics, which in extreme instances can make a chair uncontrollable and potentially unsafe. Penny & Giles Controls Limited accepts no liability for losses of any kind arising from failure to comply with this condition.



The chair manufacturer is responsible for always ensuring that any replacement motor or gearbox is fully compatible with the original control system. Failure to do this may result in poor control characteristics, which in extreme instances can make a chair uncontrollable and potentially unsafe. Penny & Giles Controls Limited accepts no liability for losses of any kind arising from failure to comply with this condition.



Users must not transfer a control system from one chair type to install it on a different chair type. Control systems with different part numbers may have both hardware and software differences to ensure that they are compatible with the electrical and dynamic characteristics of their specific target vehicles. The characteristics of one type of control system may not be compatible with a different, unauthorized chair. Failure to observe this warning could result in an unsafe set-up for the wheelchair user and may create a fire hazard depending on the motors, wiring, connectors and circuit breakers installed on the unauthorized chair. Penny & Giles Controls Limited accepts no liability for losses of any kind arising from failure to comply with this condition.

8.3 INVERT M1 DIRECTION

This inverts the direction of rotation of motor channel M1. On a standard VR2, M1 relates to the left motor channel. The parameter can be set to on or off.

On means the motor output, M1, will be inverted.

Off means the motor will rotate in the normal direction.

8.4 INVERT M2 DIRECTION

This inverts the direction of rotation of motor channel M2. On a standard VR2, M2 relates to the right motor channel. The parameter can be set to on or off.

On means the motor output, M2, will be inverted.

Off means the motor will rotate in the normal direction.

8.5 MOTOR SWAP

This swaps the motor output channels of the VR2. I.e. left becomes right and right becomes left. The parameter can be set to on or off.

On Means the motor outputs will be swapped.

Off Means they will not.

8.6 TORQUE

The Torque parameter boosts the current to the motors at low speed settings. If the motor is stalled, for example, the wheelchair is stuck against an obstacle, such as a door threshold; then this will be automatically detected and the current to the motors will be increased, allowing the obstacle to be overcome.

Torque can be set between 0% and 100%

A value of 0% means the Torque parameter has no effect. Higher values mean that more current will be permitted in the described stall conditions.



Ensure that the motor compensation is set correctly for the chair, torque does not counter the effects of incorrect compensation settings.



The higher the Torque setting the more responsive the chair becomes to joystick commands. If set too high, the chair can have a jerky or jumpy feel.

8.7 TREMOR DAMPING

This parameter allows the effects of hand tremor to be reduced. If the user has a condition that results in hand tremor, then increasing the value of Tremor Damping will reduce the effect of the tremor, making the wheelchair more controllable.

Tremor Damping can be set between 0% and 100%

A value of 0% means Tremor Damping has no effect. Note, even at this value, there is inherent damping in the control system. Higher values apply a higher level of damping.



The higher Tremor Damping is set the slower joystick response will become.



When setting Tremor Damping, pay particular attention to stopping distances. As the parameter dampens the response to the joystick commands, stopping distance can be affected. To stop the wheelchair with Tremor Damping activated you must release the joystick and allow it to center. It is the responsibility of the wheelchair manufacturer to ensure requirements on stopping distances are adhered to.

8.8 JOYSTICK STATIONARY TIME

If the joystick is held in a deflected position i.e. away from center for a period of time exceeding this value, it is assumed the deflection is accidental and drive to the motors will be cut. The programmable range is 0-60 minutes in steps of 1 minute. A value of 0 disables this function.

It is not normally necessary to adjust this parameter.



The value of both this parameter has been selected by the wheelchair manufacturer in order to minimize the risk of motor damage. Do not adjust these values without consulting the wheelchair manufacturer. Penny & Giles Controls Limited accepts no liability for losses of any kind resulting from the adjustment of this parameter.

8.9 JOYSTICK STATIONARY RANGE

This sets the window within the joystick is considered to be stationary. If the joystick moves by more than this value, the timer is reset.

It is not normally necessary to adjust this parameter.



The value of this parameter has been selected by the wheelchair manufacturer in order to minimize the risk of motor damage. Do not adjust these values without consulting the wheelchair manufacturer. Penny & Giles Controls Limited accepts no liability for losses of any kind resulting from the adjustment of this parameter.

8.10 DEMAND CLIPPING (R-NET)

Demand clipping is necessary to ensure good speed and direction control of the wheelchair in all circumstances, including heavy loads and low battery conditions.

Off If set to Off it uses the standard VR2 algorithm.



On If set to On it uses the R-net version of the demand clipping algorithm.

In some wheelchair application setting the parameter On can allow allows higher speeds to be maintained when making regular course adjustments.

8.11 TURNING TORQUE



nVR2 PM50 & nVR2 PM 60 Only

Turning Torque is a way of boosting the Current to the motors when a wheelchair is attempting to turn at low speeds under a heavy load.

Example: Attempting to turn on a thick carpet. If the wheelchair is stalled and the controller is receiving a turn signal, the current applied to the motor will be gradually increased to a value of Current Limit Max. in attempt to clear the obstacle.

As soon as the obstacle is cleared then the current is gradually stepped down until normal operating current is achieved.

Turning Torque can be set between 0 and 100% in steps of 5%.

0% Represents no increase in the current.

100% Represents the Current Limit Max setting.



This is dependent on the resistance of the motors connected, if the resistance is high then Current Limit Max may not be achievable.



Ensure that the motor compensation is set correctly for the wheelchair.

8.12 MOTOR STALL TIMEOUT



nVR2 PM 50 & nVR2 PM 60 Only

If the Current Foldback Threshold is exceeded for the duration of Motor Stall Time, drive to the motor will be cut. Release the joystick and turn the controller off and on again. This feature can be used to protect the motor from undue stress.

Motor Stall Timeout is programmable between 0 (off) and 180 seconds.



9 MEMORY FUNCTIONS

The VR2 has a timer and a diagnostic log. These can be read and cleared using the PP1a Programmer or the PC Programmer.

9.1 READ TIMER

The VR2 has a timer which records how long the wheelchair is in use. The timer runs whenever the joystick is moved away from the center position, and stops when the joystick is returned. The timer records the number of hours the wheelchair has been in use.

9.2 CLEAR TIMER

This function resets the VR2's timer. This function is only present in the OEM and Manufacturing versions of the PC Programmer.

9.3 READ SYSTEM LOG

The VR2 has a diagnostic log facility which stores the number of occurrences of the last eight detected system problems. This allows you to view the contents.

9.4 ERASE SYSTEM LOG

This function clears the VR2's diagnostic log. This function is only present in the OEM and Manufacturing versions of the PC Programmer.

9.5 SERVICE LOG

This records the actual number of hours that the wheelchair was in use before a service was undertaken. The record is made each time the Service Timer is programmed to the next service interval. An example is given below.

The first service interval is set for 1000-hours, i.e. Service Timer = 1000h. However, the service is actually conducted at 1050-hours. After this service, the Service Timer is set for the next service interval and it is at this point that 1050h will be written to the Service Log.

This facility allows a wheelchair OEM or service agent to determine if the required service routine has been carried out.



CHAPTER 5 – LIGHTING MODULE

1 INTRODUCTION

This section of the manual describes the operation, installation and programming differences generated by the VR2 lighting system. The VR2 lighting system comprises of:

VR2-L: VR2 Power Module, Joystick Module fitted with lighting control buttons and a VR2 lighting module (VR2-LM)



The VR2-L cannot be used in conjunction with nVR2 PM 50 & nVR2 PM 60

2 CONTROLS

There are common controls between the VR2 and VR2-L control system that operates as previously described in Chapter 1. Where a control has been moved this will be noted, however where a control has changed a description of its new functionality and use will be given.

All information regarding handling advice, cleaning requirements and overall controls described in Chapter 1 should be followed.

Refer to the illustration on the following page for the new VR2-L control layout.

2.1 ACTUATOR BUTTON AND LEDS

Depending on whether the VR2 is programmed with 1 or 2 actuators, the operation of this button will differ. Refer to the relevant section below. For actuator programming, refer to Chapter 4.

2.1.1 WHEELCHAIRS WITH ONE ACTUATOR

Depressing the actuator button once will enter actuator adjustment mode. This will be indicated by the illumination of both actuator LEDs. Actuator adjustment can then be made by deflecting the joystick forwards and backwards.

To re-enter drive mode depress either the actuator button or a speed button.

2.1.2 WHEELCHAIRS WITH TWO ACTUATORS

Depressing the actuator button will enter actuator adjustment mode. Depressing the button once illuminates the LEFT LED, and deflection of the joystick forwards or backwards will adjust the actuator connected to that channel. Selection between the two actuators is achieved by deflecting the joystick to the left and right. As the actuator selected changes then so will the LED, which illuminates. LEFT for actuator 1 and RIGHT for actuator 2.

To re-enter drive mode depress the actuator button again or depress either speed button



Joystick Module

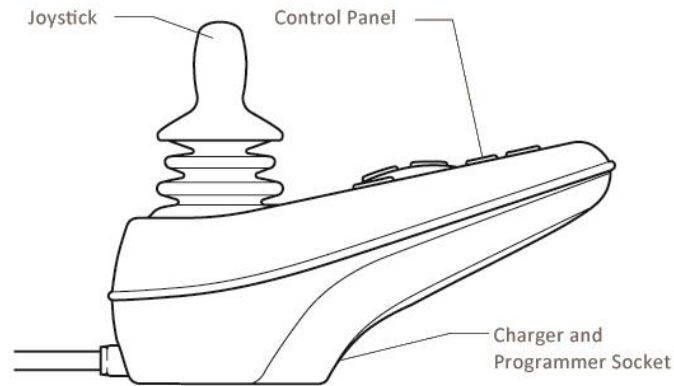

Control Panel Variants

No Actuator



With Actuators



Controls



Battery Gauge



On/Off Button



Horn Button



Lights Button

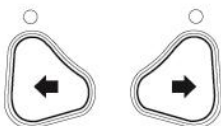

Indicator Buttons



Maximum Speed / Profile Indicator

Speed / Profile Decrease Button

Speed / Profile Increase Button



Actuator Button



Hazards Button

2.2 LIGHT BUTTON INDICATOR

To turn on the wheelchair's lights operate this button, the associated LED will illuminate continuously.

If the LED flashes a short circuit in the lighting circuit has been detected.



Depress the light button to turn off the lights and associated LED.

2.3 LEFT TURN INDICATOR BUTTON AND LED

To turn on the wheelchair's left turn indicator operate this button, the associated LED will flash at the same rate, synchronously with the indicator.

If the LED flashes rapidly either a total short circuit, a single lamp open circuit or a total open circuit in the left side indicator circuit has been detected.

Depress the left indicator button to turn off the indicators and associated LED.

2.4 RIGHT TURN INDICATOR BUTTON AND LED

To turn on the wheelchair's right turn indicator operate this button, the associated LED will flash at the same rate, synchronously with the indicator..

If the LED flashes rapidly either a short circuit, a single lamp open circuit or an open circuit in the right side indicator circuit has been detected.

Depress the right indicator button to turn off the indicators and associated LED.

2.5 HAZARD WARNING BUTTON AND LED

To turn on the wheelchair's hazard warning lamps operate this button, the associated LED will flash at the same rate. The left and right turn indicator LEDs will also flash

If the LED's flash rapidly either a short circuit, a single lamp open circuit or an open circuit in the entire indicator circuit has been detected.

Depress the hazard warning button to turn off the lights and associated LED.

3 LIGHTING MODULE INSTALLATION

3.1 MOUNTING

The lighting module should be mounted vertically, with the connector sockets pointing down, using M3.5 (Europe) or #6-40 (USA) screws.

The lighting module must be mounted in a position where it is not exposed to conditions of water or dust above those specified in ISO7176/9.

Do not mount the lighting module in a position which would expose it to excessive shock or vibration. The lighting module is designed to withstand levels of shock and vibration experienced when mounted to the chassis of a wheelchair; and has been tested in accordance with BS2011 part 2.1Eb (1987) and BS2011 part 2.1Fd (1973) for Bump and Random Vibration respectively. Direct impacts onto the lighting module should be avoided. Contact PGDT if you need further advice.

Mount this way up

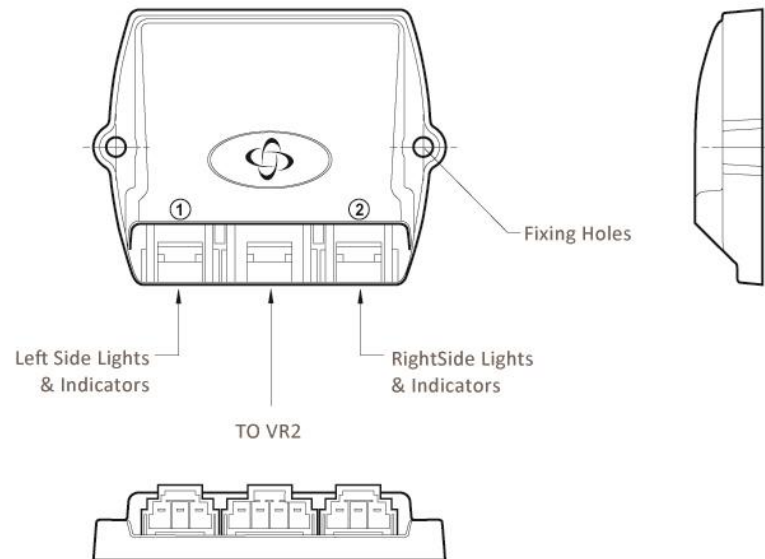

It is possible for the case temperature of the Lighting Module to rise above 41°C (107°F). For this reason the Lighting Module should be fixed in a position where it cannot be touched by the wheelchair user.

3.2 CONNECTION

The lighting module has three connector sockets. Refer to the illustration in section 3.1.

3.2.1 SOCKET 1

This socket accepts a Hirose DF7 series 3 way connector for the control of the LEFT side lights. Refer to the illustration in section 3.4 for details.

3.2.2 SOCKET 2

This socket accepts a Hirose DF7 series 3 way connector for the control of the RIGHT side lights. Refer to the illustration in section 3.4 for details.

3.2.3 SOCKET 3

This socket is the power and communications connection from the VR2-L and accepts the lighting module connection from the VR2-L spur. This socket has no identification number.

3.3 OUTPUT

The maximum current ratings of the Indicator and Lighting outputs are as stated below.

INDICATORS – 3.5A

LIGHTS – 1.75A



These outputs are self-protecting and do not require fuses or circuit breakers.

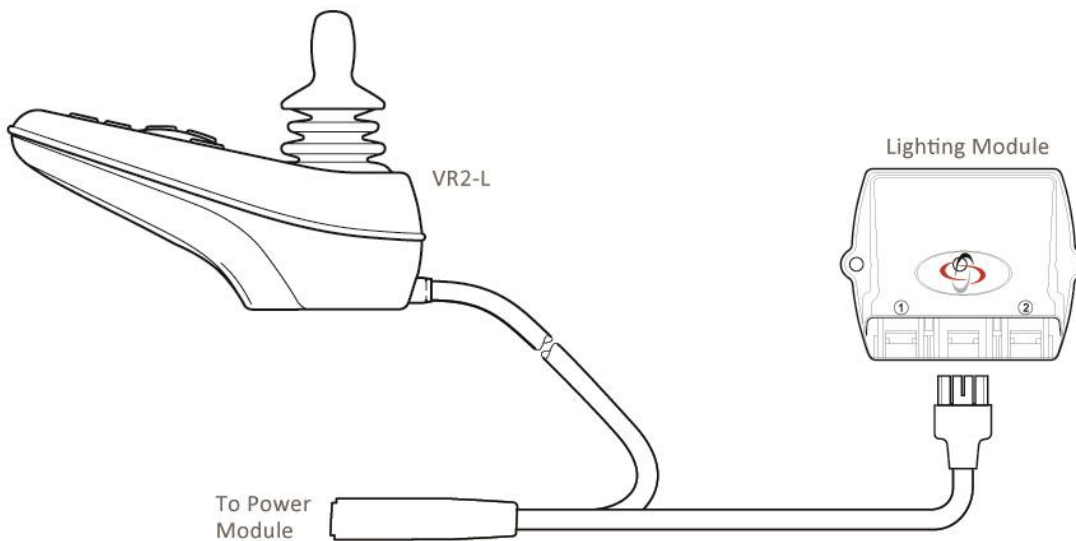

3.4 WIRING



For lighting module sockets 1 and 2 only use the exact parts specified below for the mating connector.

Refer to the following illustration for more detail.

HRS part numbers: Housing DF7-3S-3.96C
 Crimps DF7-1618SCF

PG Drives Technology: Connector Boot P76720

As an alternative a complete kit can be purchased from PG Drives Technology.

PG Drives Technology: 3 Way Connector Kit: D50301

PGDT recommends the use of 0.75 mm² / 20 AWG Tri-Rated Equipment wire or equivalent.



Secure all cables to the wheelchair frame over as much of their length as is practical.



Penny & Giles Controls Limited accepts no liability for losses of any kind arising from damage to or failure of the wheelchair lighting system, including any associated wiring. It is the responsibility of the wheelchair manufacturer to ensure that the lighting system wiring complies with all relevant standards.

Lighting Module Wiring Detail

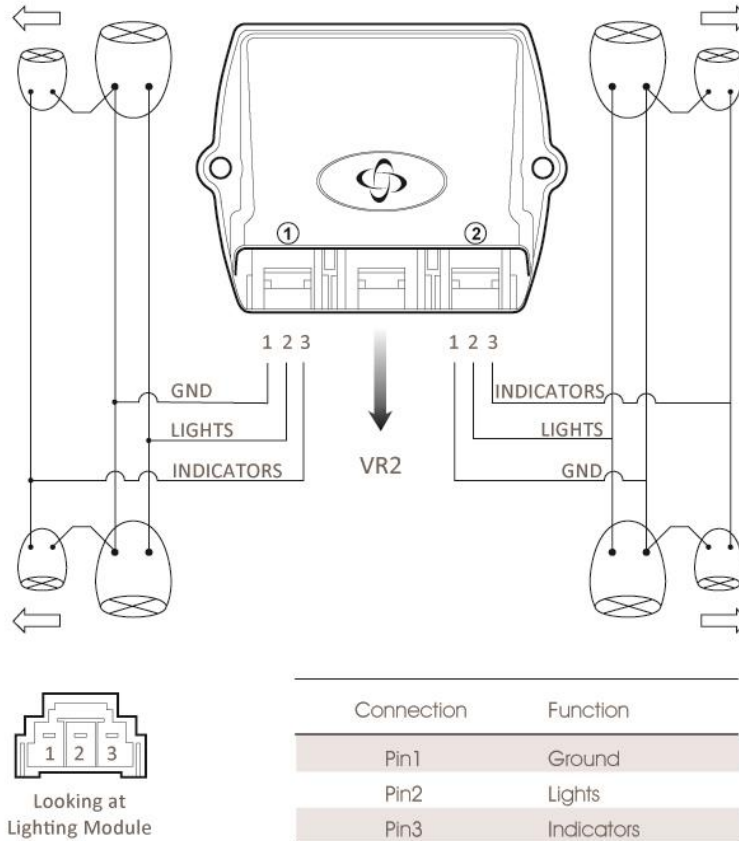

4 PROGRAMMING

The VR2-L contains 3 extra programmable parameters which are described below.

4.1 LAMP VOLTAGE

Adjusts the operating voltage for the wheelchair's lighting system. You can select either 12V or 24V. The wheelchair's lights and indicators should be fitted with lamps of the corresponding value.

If 12V is selected then the lights and indicators will remain a constant brightness, regardless of the battery voltage.

TÜV Germany require this constant brightness condition.



4.2 LAMP WATTAGE

Adjusts the control system to match the wattage (power) of the indicator lamps. Correct setting of this parameter is required to accurately detect the failure of an indicator lamp.

You can set this parameter to 5W, 10W or 21W.

TÜV Germany require that 21W lamps be used for the indicators.

4.3 INDICATOR FAULT DETECT

Sets whether the VR2-L will detect defective turn indicator lamps. You can set this parameter to On or Off.

On means the VR2-L will detect defective lamps and signal this condition to the user by flashing the relevant turn indicator LED on the VR2-L at a faster rate. Off means that defective lamps will not be detected.

If the wheelchair has just one turn indicator per side, this parameter should be set to Off.

TÜV Germany requires that indicator lamp faults, with 12V, 21W bulbs connected, are detected and the condition signalled to the user.



CHAPTER 6 – ATTENDANT MODULE

1 INTRODUCTION

This section of the manual describes the operation, installation and programming differences generated by the VR2 attendant module.

The VR2 attendant system comprises of:

VR2-DM: VR2 Power Module, Joystick, Attendant Module and an Attendant Intermediate Cable



The VR2-DM cannot be used in conjunction with VR2 PM 50 & VR2 PM 60 (D51425 – D51246) or VR2 (D51427)

This allows the drive and actuator functions of the wheelchair to be controlled either by the occupant, or by an attendant from another location on the wheelchair.

Attendant Module

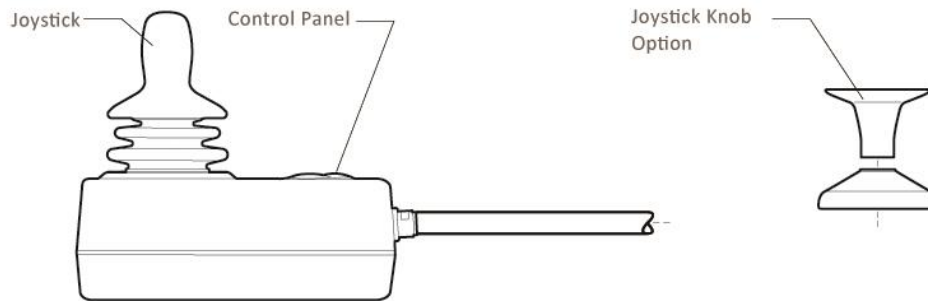

Control Panel



Controls



Maximum Speed Indicator



Maximum Speed Button



Actuator Button



Control Button & Indicator



2. CONTROLS

2.1 JOYSTICK

This controls the speed and direction of the wheelchair. Push the joystick in the direction you wish to go. The further you push it, the faster the speed. Releasing the joystick stops the wheelchair and automatically applies the brakes.

When in actuator control mode, pushing the joystick left and right will toggle selection between the available actuators. Operating the joystick in the forward and reverse directions will adjust the selected actuator.

2.2 CONTROL BUTTON AND INDICATOR

2.2.1 CONTROL INDICATOR

This shows which joystick has control. If the red wheelchair light is on, the wheelchair occupant's joystick has control. If the green attendant light is on, the attendant module systems joystick has control.

2.2.1 CONTROL BUTTON

This transfers drive control of the wheelchair between the VR2 and the attendant module system.

2.3 ACTUATOR BUTTON AND LEDS

All VR2 Attendant Module systems have an actuator button fitted as standard. If the VR2 is programmed with 0 actuators then this button has no function.

However, if VR2 is programmed with 1 or 2 actuators, the operation of this button will differ. Refer to the relevant section below.

2.3.1 WHEELCHAIRS WITH ONE ACTUATOR

Depressing the actuator button once will enter actuator adjustment mode. This will be indicated by the illumination of both actuator LEDs. Actuator adjustment can then be made by deflecting the joystick forwards and backwards.

To re-enter drive mode, depress either the actuator button or the speed button.

2.3.2 WHEELCHAIRS WITH TWO ACTUATORS

Depressing the actuator button will enter actuator adjustment mode. Depressing the button once illuminates the LEFT LED, and deflection of the joystick forwards or backwards will adjust the actuator connected to that channel. Selection between the two actuators is achieved by deflecting the joystick to the left and right. As the actuator selected changes then so will the LED, which illuminates. LEFT for actuator 1 and RIGHT for actuator 2.



To re-enter drive mode, depress either the actuator button or the speed button

2.4 MAXIMUM SPEED BUTTON AND INDICATOR

2.4.1 MAXIMUM SPEED INDICATOR

This shows the maximum speed setting for the wheelchair when the Attendant Module system has control. There are five settings - setting 1 is the lowest speed and setting 5 is the highest speed. The speed setting is changed with the speed button.

2.4.2 MAXIMUM SPEED BUTTON

This sets the maximum speed of the wheelchair when the Attendant Module system has control.

Depressing the button increases the controller's maximum speed by one step until it has reached step 5. The next depression then brings the speed back down to step 1.

If the control system is programmed for drive profile operation, then the attendant module system speed adjuster button will only adjust the speed within the selected profile.

Changing between drive profiles can only be achieved using the VR2.

3 INSTALLATION

The Attendant Module has four holes for mounting on the underside. Refer to the following illustration for details of the hole positions. The holes are tapped with an M5 thread to a depth of 10mm (3/8").

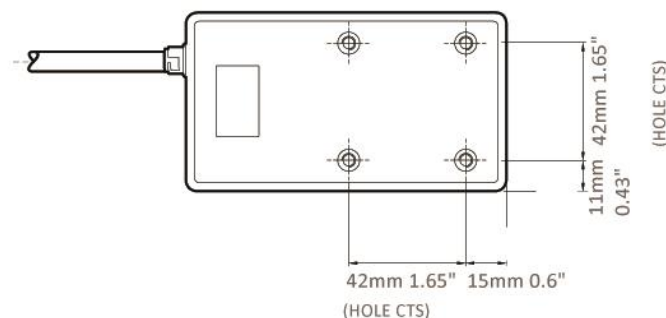

View of underside

The Attendant Module is not sensitive to mounting orientation except where it is exposed to water or dust. In this situation the control system must be mounted with the joystick shaft pointing vertically upwards in order to maintain the attendant module's IPx4 rating.

Do not mount the Attendant Module in a position which would expose it to excessive shock or vibration. The Attendant Module is designed to withstand levels of shock and vibration experienced when mounted to the chassis of a wheelchair; and has been tested in accordance with BS2011 part 2.1Eb (1987) and BS2011 part 2.1Fd (1973) for Bump and Random Vibration respectively. Direct impacts onto the Attendant Module system should be avoided.

Contact PGDT if you need further advice.



When the Attendant Module has been installed and connected the joystick may need re-orientation. Refer to section 5 of this part of the manual for details.

4 CONNECTION

Secure all cables to the wheelchair frame over as much of their length as is practical.

4.1 CONNECTION TO THE VR2 ATTENDANT MODULE

The VR2 Attendant Module system is connected to the VR2 Attendant module Control System via a designated cable as shown below using the cable supplied.

VR2 Attendant Module System Configuration

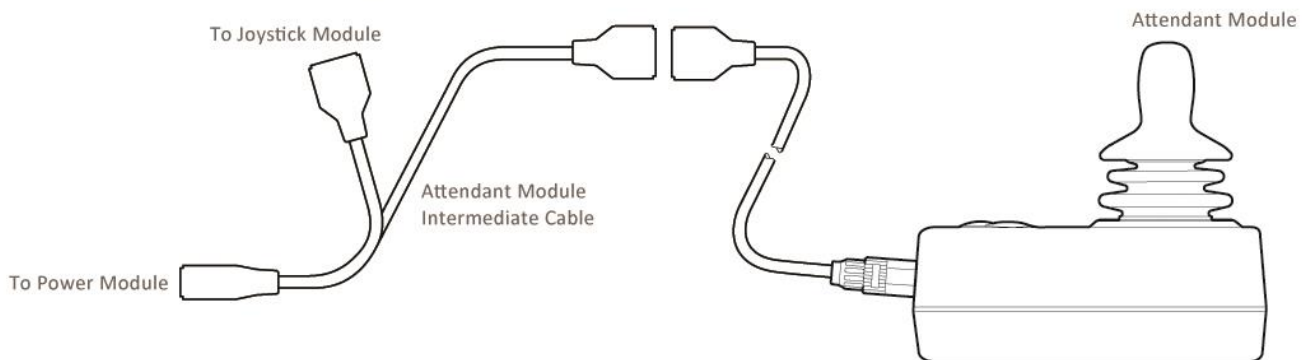

4.2 VR2 ATTENDANT MODULE & LIGHTING MODULE

Including a VR2 Attendant Module into a lighting configuration.

VR2 Attendant Module System Configuration

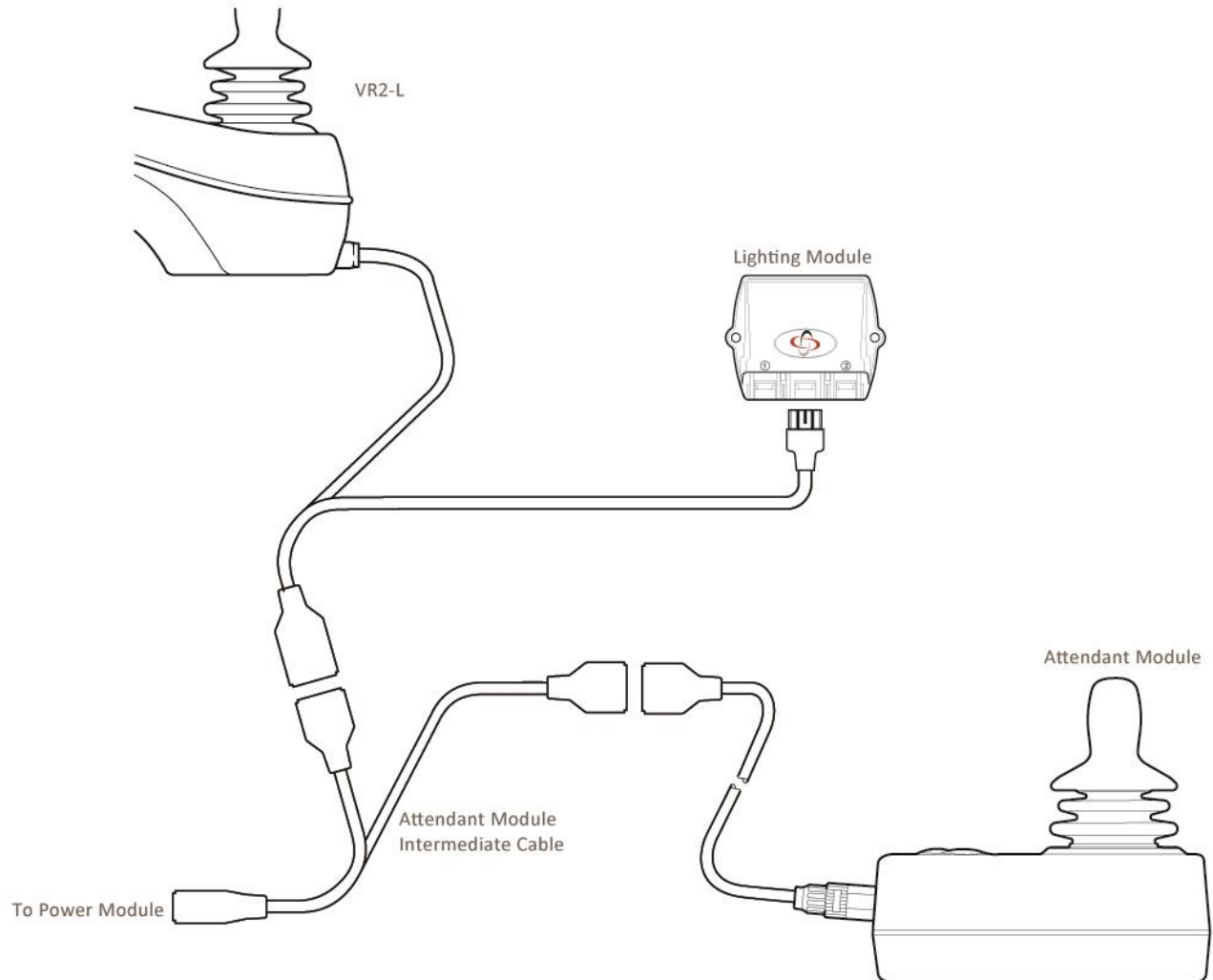



5 JOYSTICK ORIENTATION

Reorientation of the joystick is only required when the Attendant Module system has been mounted on a wheelchair so that the control buttons are not facing in the wheelchairs forward drive direction.

Reorientation is achieved as follows:

- Ensure the Control of the VR2 has been set to the Attendant Module system. The Green LED indicating the attendant module system is in control must be illuminated.
- Turn the entire system off at the VR2, by pressing the ON/OFF button.
- On the Attendant Module system hold the speed button down and the joystick displaced from center at the same time as turning the system back on at the VR2, by pressing the ON/OFF button. Continue to hold the speed button and joystick until the Green and Red control LED's on the attendant module system begin to flash alternately. This will occur after approximately 5 seconds. Also at this time the speed display will go blank.
- Release both.
- Press the speed button again, the control LED's will both illuminate and 1 LED on the speed display will be visible.
- Fully deflect the joystick to the desired forward position and press the speed button. Now 2 LED's on the speed display will be visible.
- Fully deflect the joystick to the desired left position and press the speed button. The speed display will now be flashing all 5 LED's.

If the reorientation has been unsuccessful then the speed display will show only one LED. In this instance repeat the entire sequence.

- Turn the entire system off and on again at the VR2, by pressing the ON/OFF button, before attempting to drive.

CHAPTER 7 – SERVICING & DIAGNOSTICS

1 SERVICING

1.1 INTRODUCTION

The VR2 Joystick Module has been designed and constructed to allow field replacements of some key components.

The replaceable components are:

The Joystick.

The Joystick Cable.

The Keypad.

Note: nVR2 JSM, the cable cannot be replaced.

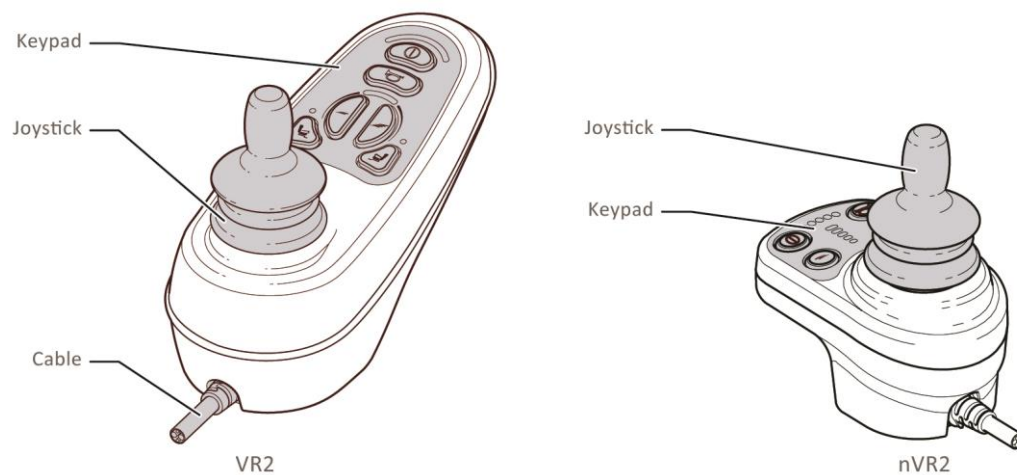

Any replacement work carried out without the wheelchair manufacturer's permission will invalidate the control system's warranty. Penny & Giles Controls Limited accepts no liability for losses of any kind if the procedure and safety guidelines are not followed. These operations should only be carried out by a trained Healthcare Technician.



While performing the following operations, the technician should use anti-static protection such as the RadioShack 276-2397 or Farnell 8247056 anti-static wristbands. PG Drives Technology recommends anti-static protection to specification IEC 61340-5-2. Failure to use the correct anti-static protection could cause damage to the control system. Penny & Giles Controls Limited accepts no liability for losses of any kind if the correct anti-static protection measures are not followed.

1.2 JOYSTICK REPLACEMENT (VR2)

1.2.1 JOYSTICK REMOVAL

- Isolate the Joystick Module by disconnecting the Joystick Cable from the Power Module.
- Remove the 5 retaining screws from the underside of the Joystick Module.

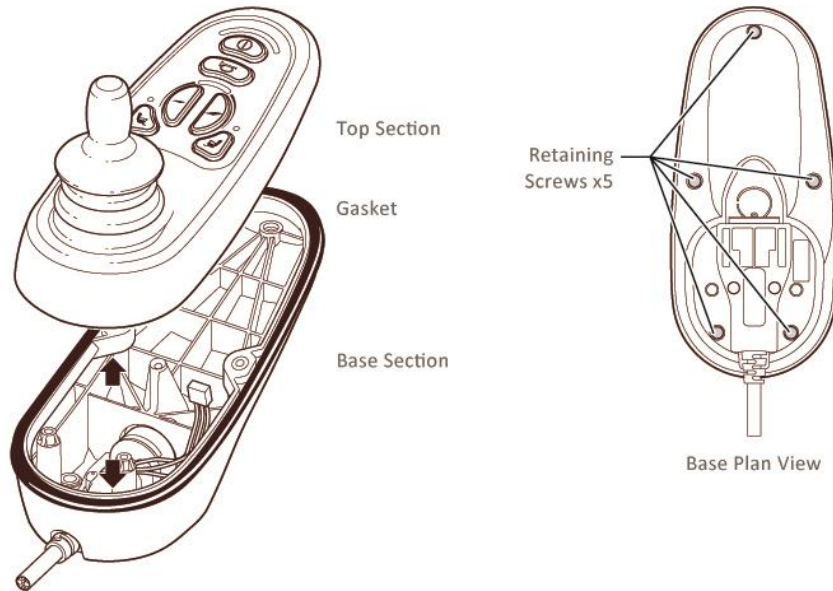

- Disconnect the Ribbon Cable from the joystick.

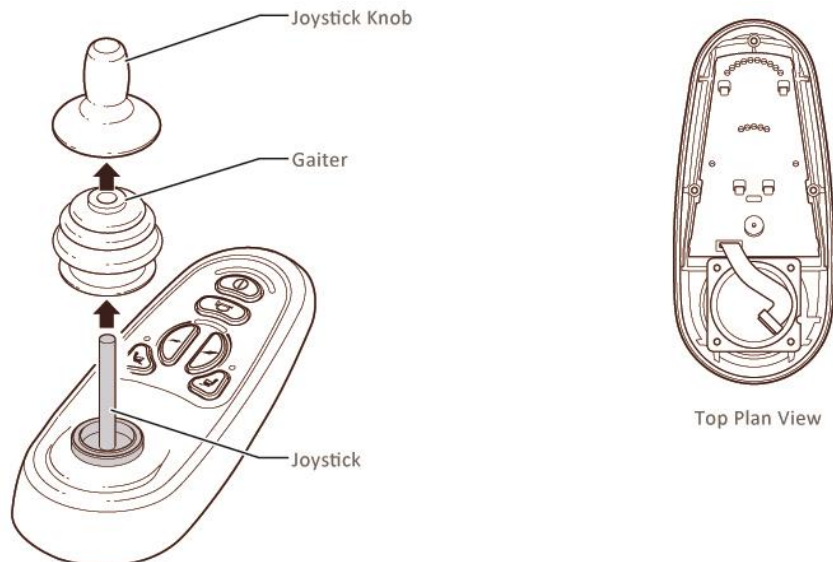

- Remove the Joystick knob.
- Remove the 2 retaining screws from the joystick base.

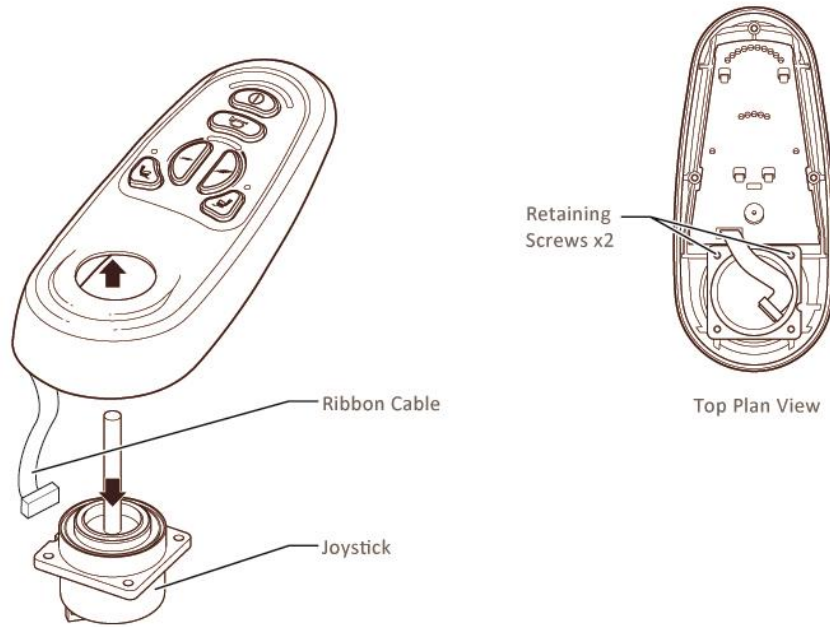

- Slide joystick out through the Top Section.
- Remove the Gaiter/Rubber-Boot.

1.2.2 FITTING A JOYSTICK

Ensure Gaiter/Rubber-boot is positioned with the flange firmly against the underside of the Top Section.

Ensure the joystick is in the correct orientation. The notch on the joystick plate should lineup with the Key in the Top Section.

- Slide joystick up through the Top Section.
- Check the seal of the Gaiter/Rubber-boot and secure using the 2 retaining screws. Tightening to 0.8Nm, 7 inch/lbs.
- Connect the Joystick Cable to the Power Module.
- Power up the VR2 with the Joystick Ribbon Cable disconnected. The VR2 should flash the left most speed Led.
- The VR2 will now enter the **Calibration sequence**.
- Connect the Ribbon Cable and make sure the joystick is centered.
- Press the horn key until the VR2 bleeps.
- The 2 left most speed display LEDs will flash.
- Push and hold the joystick fully forward and press the horn key until the VR2 bleeps.
- The 3 left most speed display LEDs will flash.
- Push and hold the joystick fully to the left and press the horn key until the VR2 bleeps.



- The 4 left most speed display LEDs will flash.
- Push and hold the joystick fully to the right and press the horn key until the VR2 beeps.
- All 5 speed display LEDs will flash.
- Pull the Joystick fully back and press the horn key until the VR2 beeps.
- The speed display will go out and the TruCharge display will flash all 10 LEDs.
- Turn the VR2 off.
- Isolate the Joystick Module by disconnecting the Joystick Cable from the Power Module.
- Reassemble the joystick module, ensuring the rubber gasket is correctly positioned, and replace the 5 retaining screws.
Tightening to 0.8Nm, 7 inch/lbs



Incorrect fitting of the Gasket could seriously affect the Joystick Module's resistance to moisture ingress.

- Turn the controller on again.

If the replacement or the calibration sequence has been unsuccessful the TruCharge display will flash 7 bars. Refer to Chapter 1 Section 8.5.

If the Joystick does not operate correctly, or if the calibration sequence does not appear, then run through the following:

Check that Joystick Module is receiving power from the Power Module.

- The LEDs should light up

- Repeat the replacement procedure, ensuring that all the cables are securely connected and that the connectors clean, clear and not damaged.
- Repeat the calibration procedure.

1.3 JOYSTICK REPLACEMENT (NVR2)

1.3.1 JOYSTICK REMOVAL

- Isolate the Joystick Module by disconnecting the Joystick Cable from the Power Module.
- Remove the 4 retaining screws from the underside of the Joystick Module.
- Separate the Top and Base sections.
- Disconnect the Cable from the PCB.

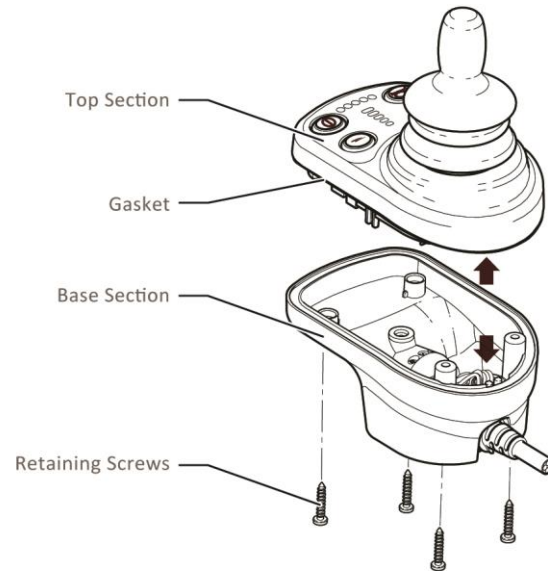

- Turn the Top section over.

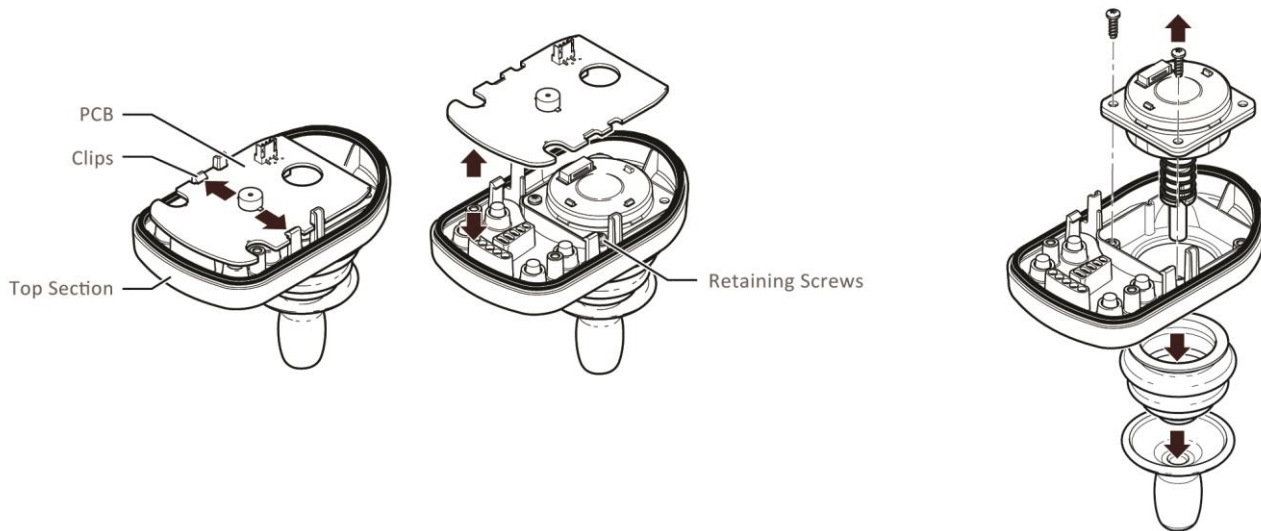

- Carefully push the clips apart allowing the PCB to be lifted away.
- Locate the 2 retaining screws and remove.
- Remove the Gaiter/Rubber-Boot.
- Lift the joystick out of the body section.

1.3.2 FITTING A JOYSTICK

Ensure Gaiter/Rubber-boot is positioned with the flange firmly against the underside of the Top Section.

Ensure the joystick is in the correct orientation. The notch on the joystick plate should lineup with the Key in the Top Section.

- Replace the Gaiter/Rubber-boot and check the seal
- Slide joystick up through the Top Section.
- Secure using the 2 retaining screws. Tightening to 0.8Nm, 7 inch/lbs.
- Position the PCB so the connectors align and push gently until the PCB “clicks” into place with the clips holding it securely.
- Connect the PCB to the cable.
- Reassemble the joystick module, ensuring the rubber gasket is correctly positioned, and replace the 4 retaining screws. Tightening to 0.8Nm, 7 inch/lbs



Incorrect fitting of the Gasket could seriously affect the Joystick Module’s resistance to moisture ingress.

- Turn the controller on again.

1.3.3 JOYSTICK CALIBRATION

In the unlikely event of the nVR2 not achieving full drive, the new joystick may need to be calibrated.

To calibrate a joystick:

- Isolate the module.
- Disconnect the Top and Base sections as described previously.
- Release the PCB without disconnecting it from the Cable.
- Reconnect the module to the Power Module.
- Power up the nVR2 by holding a suitable flat metal object across the PCB On/Off contact. The nVR2 will flash the first speed Led.
- The nVR2 will now enter the **Calibration sequence**.
- Push the PCB back into position, connecting the joystick and make sure the joystick is centered.
- Press the horn key until the nVR2 bleeps.
- The first 2 speed display LEDs will flash.
- Push and hold the joystick fully forward and press the horn key until the nVR2 bleeps.
- The first 3 speed display LEDs will flash.



- Push and hold the joystick fully to the left and press the horn key until the nVR2 bleeps.
- The first 4 speed display LEDs will flash.
- Push and hold the joystick fully to the right and press the horn key until the nVR2 bleeps.
- All 5 speed display LEDs will flash.
- Pull the Joystick fully back and press the horn key until the nVR2 bleeps.
- The speed display will go out and the battery display will flash all 5 LEDs.
- Turn the nVR2 off.
- Isolate the Joystick Module by disconnecting the Joystick Cable from the Power Module.
- Reassemble the joystick module, ensuring the rubber gasket is correctly positioned, and replace the 4 retaining screws.
Tightening to 0.8Nm, 7 inch/lbs



Incorrect fitting of the Gasket could seriously affect the Joystick Module's resistance to moisture ingress.

- Turn the controller on again.

If the replacement or the calibration sequence has been unsuccessful the TruCharge display will flash 7 times. Refer to Chapter 1 Section 8.5.

If the Joystick does not operate correctly, or if the calibration sequence does not appear, then run through the following:

Check that Joystick Module is receiving power from the Power Module.

- The LEDs should light up
- Repeat the replacement procedure, ensuring that all the cables are securely connected and that the connectors clean, clear and not damaged.
- Repeat the calibration procedure.

1.4 JOYSTICK CABLE REPLACEMENT

1.4.1 JOYSTICK CABLE REMOVAL

- Isolate the Joystick Module by disconnecting the Joystick Cable from the Power Module.
- Remove the 5 retaining screws from the underside of the Joystick Module.
- Disconnect the Serial Cable from the PCB.

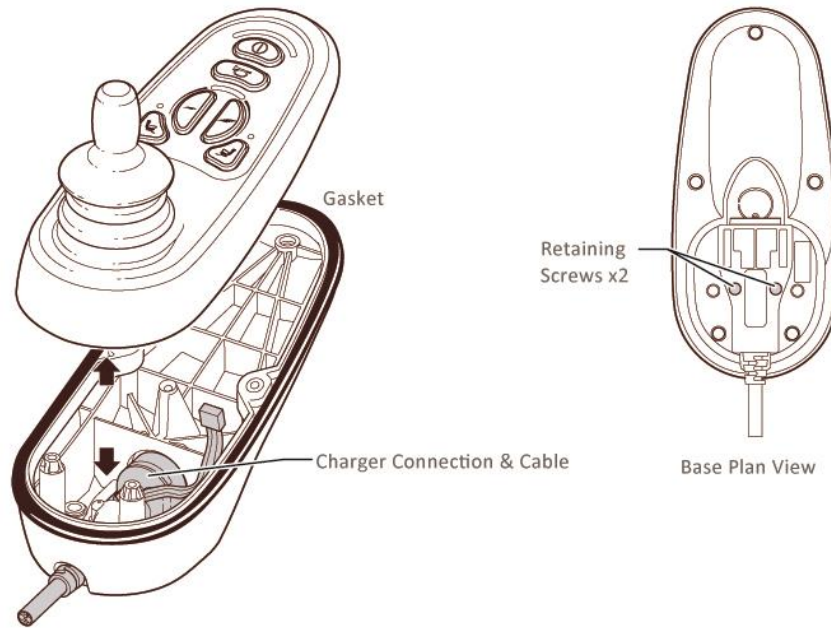

- Remove the 2 retaining screws holding the Charger Socket and Cable.
- Slide the Charger Socket and Cable out of the plastic base.

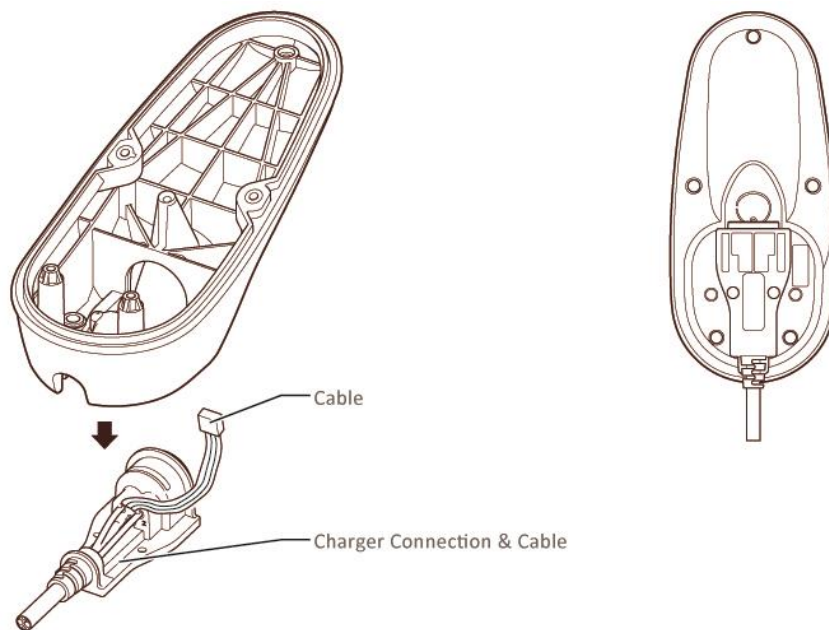

1.4.2 FITTING A JOYSTICK CABLE

- Insert the new Charger Socket and Cable into the plastic case.
- Attach the cable from the new Charger Socket and Cable onto the PCB.
- Secure the Charger Socket and Cable with the 2 retaining screws.
- Reassemble the joystick module, ensuring the rubber gasket is correctly positioned, and replace the 5 retaining screws.



Incorrect fitting of the Gasket could seriously affect the Joystick Module's resistance to moisture ingress.

- Connect the Joystick Cable to the Power Module.
- Turn the controller on.

If the procedure has not been followed correctly or the cable is faulty the TruCharge display will flash 7 bars and the Speed Indicator will flash all 5 LEDs. Refer to Section 3.

At this point:

- Check all connections.
- Repeat the procedure.
- Should the procedure fail twice try a new cable.

1.5 KEYPAD REPLACEMENT

- Disconnect Joystick Cable from the Power Module.
- Gently lift the top corner of the keypad, with a scalpel.
- Remove the damaged keypad.
- Ensure surface area is clear, clean and free of adhesive.
- Place the new keypad into position, ensuring there are no gaps around the edges, and press firmly to stick.
- Re-connect Joystick Cable to the Power Module.
- Turn control system on and check the operation of the buttons.

If trouble is experienced activating any of the buttons ensure that the pad is correctly positioned and firmly adhered to the joystick module's surface.



Incorrect fitting of the Keypad could seriously affect the Joystick Module's resistance to moisture ingress.



2 DIAGNOSTICS

2.1 INTRODUCTION

The primary objective of this section is to assist service personnel in finding the likely area of a detected fault within the whole wheelchair electrical system. It is important to realize that even though the control system is signalling a fault, it may not be the control system itself that is defective. This is because the control system is able to detect problems in other electrical components (motors, batteries, solenoid brakes etc.) or, more importantly, the wiring to them. When a control system has detected a fault a system trip is indicated.

Using this guide, it is possible to define a trip as belonging to one of 10 types. Once this type has been established, there are suggestions as to what the possible cause may be.

The guide should only be used to decide the starting point of your own diagnosis, as it is possible for the controller to indicate a fault in another component even though the controller itself may be defective. Nevertheless, experience has shown that connectors and wiring are the major cause of wheelchair electrical problems, so it is necessary to examine these more vulnerable areas first.

Diagnostics should only be conducted by healthcare professionals with in-depth knowledge of PGDT electronic controllers. An incorrect or badly effected repair could result in an unsafe set-up of a wheelchair. PGDT accept no liability for losses of any kind arising from an incorrect or badly effected repair.

2.2 DIAGNOSTICS PROCESS

For efficient and effective diagnosis the following basic steps should be taken.

- Establish the type of control system fitted to the wheelchair.
- Confirm there is a trip, or has been an intermittent trip.
- Establish the trip type.
- Refer to the trip table.
- Refer to the possible cause as indicated by the trip table, and carry out recommended investigative and corrective action.

2.3 DETECTING A TRIP HAS OCCURRED

Firstly observe the control system's TruCharge (battery gauge) display. This will behave as described in one of the following sections.



Refer to Chapter 3 section 2.1 for operational details of the 5 LED battery display (D51575).

2.3.1 FLASHING RAPIDLY



The control system is tripped.

- Connecting a programmer to the control system while this is happening will give you a trip code.
- To determine the trip type, refer to section 3.

2.3.2 FLASHING SLOWLY

No trip is currently detected by the control system. The slow flash is an indication that the batteries require charging.

- A trip may have occurred previously, read the control system's diagnostic log, then refer to section 3 to establish the trip type.

2.3.3 DISPLAY IS STEADY

No trip is currently detected by the control system.

- A trip may have occurred previously, read the control system's diagnostic log, then refer to section 3 to establish the trip type.

2.3.4 DISPLAY DOES NOT ILLUMINATE

No power is reaching the control system.

- Ensure the batteries are fully charged and that all connections between batteries and the control system are made.
- If these connections are good, then the Power Module may be defective, refer to Section 5.

2.3.5 ACTUATORS DO NOT RESPOND

If the vehicle has more than one actuator, check to see how many are not working.

- Check that all connections between the control system and the actuator motors are correct.
- Check that the actuator motor is not faulty.
- This can be achieved by disconnecting the control system and routing power straight to the Actuator motor in question.
- If the actuator motor is not faulty check the connections between the control system modules are correct.
- If the connections are good, then the Power Module may be defective, refer to Section 5.

2.4 OTHER CONDITIONS

This covers conditions that are not displayed as trip codes or on the TruCharge display. This may be because: either the control cannot switch on; the condition is not considered critical enough to force a trip or the control system cannot detect the condition.



2.4.1 CONTROL SYSTEM WILL NOT SWITCH ON

- Check the battery connections to the control system. If these appear to be good, then the Power Module may be defective, refer to section 5.
- Check the cable between the Power Module and the Joystick Module. If this appears to be good, then either module may be defective, refer to section 5.

2.4.2 WHEELCHAIR DRIVES SLOWLY

This could be caused by one of the following.

- The control system has been incorrectly programmed.
- A speed limiting function is active, e.g. seat in a raised position on wheelchairs fitted with lifting seats.
- Defective motor or defective brake.

2.4.3 WHEELCHAIR WILL NOT DRIVE IN A STRAIGHT LINE

This could be caused by a defective motor or defective brake.

2.4.4 ONE MOTOR OR BRAKE BECOMES VERY WARM

This could be caused by a defective motor or defective brake.

2.4.5 BATTERIES DISCHARGE VERY QUICKLY

The batteries can discharge very quickly for several reasons, these are described below.

- Worn or damaged batteries – check battery condition.
- Charger defective or incorrect charger being used – check charger operation (refer to wheelchair's operating manual).
- Incorrect batteries being used – refer to wheelchair manufacturer's instructions for correct battery types.
- One motor or brake jamming.



The ambient temperature has a significant effect on battery capacity. Therefore, if the temperature is lower than normal the wheelchair's range will be reduced. In this situation, the TruCharge battery gauge still gives an accurate state-of-charge reading.

2.5 TRIP DIAGNOSIS

There are two methods of trip diagnosis.



2.5.1 TRIP DIAGNOSIS WITH THE TRUCHARGE

The TruCharge Flash Codes are illustrated in Chapter 1 Section 8.5.



Refer to Chapter 3 section 2.1 for operational details of the 5 LED battery display (D51575).

2.5.2 USING A PROGRAMMER TO READ THE TRIP CODE

If you connect a programmer while the TruCharge display is flashing rapidly, then a four digit trip code will be displayed. Refer to the trip code table in section 3.



You must connect the programmer to the control system after the TruCharge display has started flashing. If the programmer is already connected when the flashing commences the trip code will not be displayed.

3 TRIP TYPES AND THEIR POSSIBLE CAUSES

Once the trip type has been established, refer to the relevant section below for further information.

Trip Code	Trip Type	Description & Reference
0A00	-	Controller in Sleep Mode - 3.18
1320	-	Timed Foldback Active - 3.16
1D05	7	JS Time Exceeded - 3.7
1500	9	Solenoid Brake Trip - 3.9
1330	7	Motor Stall Timeout
1505	9	Left Solenoid Brake Trip - 3.9
1506	9	Right Solenoid Brake Trip - 3.9
1600	10	High Battery Voltage - 3.10
1E03	Charging	Refer to section – 3.6
1E04	6	Refer to section – 3.13
1E05	Charging	Refer to section – 3.14
2C00	1	Low Battery Voltage - 3.1
2C02	-	Low Battery Lockout - 3.1
2F00	User	Refer to sections 3.7 & 3.11

Trip Code	Trip Type	Description & Reference
5400	7+S ¹	Communications Trip -3.12
7A03	A Only ²	Actuator Motor Wiring Trip -3.15
7100	7	Joystick Trip – 3.7
7101	7	Joystick Trip – 3.7
7102	7	Joystick Trip – 3.7
7103	7	Joystick Trip – 3.7
7104	7	Joystick Trip – 3.7
7105	7	Joystick Trip – 3.7
7107	7+D ³	Refer to sections 3.19
7140	7+D ³	Attendant Module Trip 3.19
7141	7+D ³	Attendant Module Trip 3.19
7142	7+D ³	Attendant Module Trip 3.19
7143	7+D ³	Attendant Module Trip 3.19
7145	7+D ³	Attendant Module Trip 3.19



3B00	2	Left Motor Disconnected – 3.2
3C00	4	Right Motor Disconnected – 3.4
3D00	3	Left Motor Wiring Trip – 3.3
3D01	3	Left Motor Wiring Trip – 3.3
3E00	5	Right Motor Wiring Trip – 3.5
3E01	5	Right Motor Wiring Trip – 3.5
4401	8	Control System Trip – 3.8

7147	7+S ¹	Attendant Module Trip 3.19
7821	-	Thermal Foldback Active – 3.17
7825	-	Thermal Shutdown – 3.17
7902	-	Thermal Foldback Active – 3.17
All Other Codes	7 or 8	Possible Control System Trip – 3.7 &
All Other Codes	7 or 8	Possible Control System Trip – 3.7 &

1 - S = Flashing Speed Indicator LED's.

2 - A = Flashing Actuator LED's.

3 – D = Flashing LED's on the Attendant Module.

3.1 TRIP TYPE 1 - LOW BATTERY VOLTAGE

This occurs when the control system detects that the battery voltage has fallen below 16V. Check the condition of the batteries and the connections to the control system.

If the trip is still present after the batteries and connections have been checked, then the Power Module may be defective. Refer to section 5.

In the case of 2C02 the Control System is making a log of the times that the Low Battery Lockout has been initiated.

3.2 TRIP TYPE 2 – LEFT MOTOR DISCONNECTED

This occurs when the control system detects that the left motor has become disconnected. Check the left motor, motor connectors and wiring.

If the trip is still present after the above checks have been made, then the Power Module may be defective. Refer to Section 5.

The VR2 control system may be programmed to exchange the left and right motor outputs. In this instance, this section will refer to the right motor. Consult the wheelchair manufacturer for more details.

3.3 TRIP TYPE 3 – LEFT MOTOR WIRING TRIP



This occurs when the control system detects a fault in the wiring to the left motor, in particular if a motor connection has short-circuited to a battery connection. Check the left motor connectors and wiring.

If the trip is still present after the above checks have been made, then the Power Module may be defective. Refer to Section 5.

The VR2 control system may be programmed to exchange the left and right motor outputs. In this instance, this section will refer to the right motor. Consult the wheelchair manufacturer for more details.

3.4 TRIP TYPE 4 – RIGHT MOTOR DISCONNECTED

This occurs when the control system detects that the right motor has become disconnected. Check the right motor, motor connectors and wiring.

If the trip is still present after the above checks have been made, then the Power Module may be defective. Refer to Section 5.

The VR2 control system may be programmed to exchange the left and right motor outputs. In this instance, this section will refer to the left motor. Consult the wheelchair manufacturer for more details.

3.5 TRIP TYPE 5 - RIGHT MOTOR WIRING TRIP

This occurs when the control system detects a fault in the wiring to the right motor, in particular if a motor connection has short-circuited to a battery connection. Check the right motor connectors and wiring.

If the trip is still present after the above checks have been made, then the Power Module may be defective. Refer to Section 5.

The VR2 control system may be programmed to exchange the left and right motor outputs. In this instance, this section will refer to the left motor. Consult the wheelchair manufacturer for more details.

3.6 TRIP TYPE 6 – CHARGER CONNECTED

This occurs when the control system detects that an off-board charger is connected. Check that the battery charger is disconnected.

If the trip is still present after the charger has been disconnected then the Joystick Module may be defective. Refer to Section 5.

3.7 TRIP TYPE 7 – POSSIBLE JOYSTICK TRIP

This occurs if the control system detects a problem within its own joystick, or there is a communications error between the Joystick Module and Power Module. The joystick can only be replaced by a person authorized by the wheelchair manufacturer.

1D05 Joystick Stationary Time Exceeded

This occurs when the joystick has been held stationary for an excessive period of time. The controller will stop drive to prevent possible damage to the wheelchair's motors. Turning the controller Off and On again will clear this error message

1330 Motor Stall Timeout



- This occurs when the current foldback threshold is exceeded by Motor Stall Timeout. The controller will stop drive to prevent possible damage to the motors.
- 7100 Loss of comms to the joystick, check the joystick cable and, if you have authorization the joystick ribbon cable, connections and mating sockets.
 - 7101 Loss of comms to the joystick, check the joystick cable and, if you have authorization the joystick ribbon cable, connections and mating sockets.
 - 7102 Loss of power to the joystick, check the joystick cable and, if you have authorization the joystick ribbon cable, connections and mating sockets.
 - 7103 Internal trip, if you have authorization check the joystick ribbon cable, connections and mating sockets. Ensure the cable is connected correctly to both the joystick and the PCB.
 - 7104 Internal trip, if you have authorization check the joystick ribbon cable, connections and mating sockets. Ensure the cable is connected correctly to both the joystick and the PCB.
 - 7105 Internal trip, if you have authorization check the joystick ribbon cable, connections and mating sockets. Ensure the cable is connected correctly to both the joystick and the PCB.

Refer to Section 1.2 for details on removal, fitting and calibration of the joystick.

If the trip is still present after the appropriate checks have been made then the Joystick Module may be defective. Refer to Section 5.

3.8 TRIP TYPE 8 - POSSIBLE CONTROL SYSTEM TRIP

This occurs if the control system detects a problem within itself. The control system can only be repaired by an authorized person. Refer to Section 5.

3.9 TRIP TYPE 9 - SOLENOID BRAKE TRIP

This occurs when the control system detects a problem in the solenoid brakes or the connections to them.

- 1500 Brake Short
- 1505 Left Brake Trip
- 1506 Right Brake Trip

Check these connections and the solenoid brakes.

If the trip is still present after the above checks have been made, then the Power Module may be defective. Refer to Section 5.

3.10 TRIP TYPE 10 - HIGH BATTERY VOLTAGE

This occurs when the control system detects that the battery voltage has risen above 35V. The most common reasons for this are overcharging of the battery or bad connections between the control system and the batteries. Check the batteries and the connections to them.

If the trip is still present after the batteries and connections have been checked, then the Power Module may be defective. Refer to Section 5.



3.11 JOYSTICK DISPLACED AT POWER-UP

The most common cause of this trip is if the joystick is deflected away from center when the control system is being switched on. When the control system is switched on, the battery gauge will blink for a short time. Check that the user is not deflecting the joystick before the blink finishes.

If the problem persists, refer to section .37.

3.12 COMMUNICATIONS ERROR

The most likely cause of a communications error is a defective cable between the Power Module and the Joystick Module. The cable should be checked for damage, and replaced if found to have a fault. The Joystick Cable can only be replaced by a person authorized by the wheelchair manufacturer, Refer to Section 1.3 for the replacement procedure.

If the problem persists then either the Power Module or the Joystick Module could be defective. Refer to Section 5.

3.13 INHIBIT 2 ACTIVE

This occurs when the Inhibit 2 input is active. The Inhibit 2 input is via the INH-2 way connector and is normally associated with speed limit or actuator functions. The operation of Inhibit 2 will depend upon the programmed settings and the wheelchair on which it is being used.

Check all wiring and switches connected to Inhibit 2. If these appear to be in working order, then the Power Module may be defective. Refer to section 5.

3.14 INHIBIT 3 ACTIVE

This occurs when the Inhibit 3 input is active. The Inhibit 3 input is via the 3 way on-board charger (OBC) and is normally associated with this function. The operation of Inhibit 3 will depend upon the programmed settings and the wheelchair on which it is being used.

Check all wiring, switches and OBC (if fitted) connected to Inhibit 3. If these appear to be in working order, then the Power Module may be defective. Refer to section 5.

3.15 ACTUATOR MOTOR WIRING TRIP

This occurs when the control system detects a fault in the wiring to either actuator motor. Check the motor connectors and wiring.

If the trip is still present after the above checks have been made, then the Power Module may be defective. Refer to Section 5.

3.16 TIMED FOLDBACK ACTIVE

This occurs when the controller is in 'Timed Foldback, i.e. the current has been reduced in order to protect the motors.

Check the motors are in good condition and are allowed to rotate freely. In particular, check the brakes are releasing fully.

3.17 THERMAL FOLDBACK ACTIVE

This occurs when the controller is in Thermal Foldback, i.e. the current has been reduced in order to protect the controller. There are three trip codes associated with this condition.

- 7821 – The current has been reduced.
- 7825 – The current has been cut completely.
- 7902 – The current has been reduced.

Check the motors are in good condition and are allowed to rotate freely. In particular, check the brakes are releasing fully.

3.18 CONTROLLER IN SLEEP MODE

This condition is indicated by the Status Indicator "blinking on" once every 2.5 seconds. It is not a trip condition, but an indication that the controller has gone to sleep.

To awake the system, switch off and on again.

3.19 ATTENDANT MODULE TRIP

The Attendant Module has its own diagnostic facility which operates in the following way:

Code: 7107

2 LEDs



If the red and green control indicator LED's are flashing rapidly and alternately, then the VR2 has tripped.

Refer to Chapter 1 section 8.5 for further details.

Codes: 7140, 7141, 7142, 7143 & 7145

3 LEDs



If 3 LEDs on the maximum speed indicator are flashing, then there is an internal trip in the Attendant Module. The Attendant Module must be disconnected and returned to PG Drives Technology.



7 bars will be flashing on the VR2, but it can be reset by disconnecting the Attendant Module and switching the control system off and on again.

Codes: 7170 & 7147



4 LEDs



If 4 LEDs on the maximum speed indicator are flashing, then the Attendant Module joystick has caused a trip. Ensure the joystick was not displaced when powering the control system up. If the joystick is centered and the trip still registers then the joystick is defective and the dual module must be disconnected and returned to PG Drives Technology.



7 bars will be flashing on the VR2, but it can be reset by disconnecting the Attendant Module and switching the control system off and on again.

4 BASIC TESTS

After a repair has been completed, the following tests should be carried out. These are minimum recommendations, depending on the nature of the original trip, additional tests may be required.



These tests are a minimum recommendation only. It is the responsibility of the service person(s) to perform other tests relevant to the original trip and wheelchair type. Refer to the wheelchair's Technical Manual for exact information of other tests. Penny & Giles Controls Limited accepts no liability for losses of any kind arising from failure to carry out of the described tests, or from not carrying out additional relevant tests.



These tests should be conducted in an open space and a restraining device such as a seat belt should always be used. Penny & Giles Controls Limited accepts no liability for losses of any kind arising from failure to comply with this condition.

4.1 GENERAL INSPECTION

Make sure all connectors are securely mated.

- Check the condition of all cables and connectors for damage.
- Check the thin rubber gaiter or boot around the base of the joystick shaft for damage. Check visually only, do not handle the gaiter.
- Make sure that all components of the control system are securely mounted.
- Do not overtighten any securing screws.

4.2 BRAKE TEST

These tests should be carried out on a level floor with at least one meter clear space around the wheelchair.

- Switch on the control system.
- Check the TruCharge display remains on, or flashes slowly, after one second.
- Push the joystick slowly forwards until you hear the parking brakes operate. The wheelchair may start to move.
- Immediately release the joystick. You must be able to hear each parking brake operate within 2 seconds.
- Repeat the test a further three times, pushing the joystick slowly backwards, left and right.

4.3 DRIVE TEST



With the maximum speed control in the minimum position, drive the wheelchair in all directions, ensuring the drive is comfortable and easy to control for the user.

Repeat the above but with the speed control set to maximum.

4.4 GRADIENT TEST



Before carrying out this test ensure another person is present to prevent the wheelchair from tipping backwards.

Drive the wheelchair forwards up its maximum rated gradient. While on the gradient release the joystick and ensure the wheelchair comes to rest and the brakes are applied without the front wheels lifting of the ground.

Deflect the joystick forwards and continue driving up the slope. Ensure the pick-up is smooth and positive.

Stop the wheelchair and reverse down the gradient. While on the gradient release the joystick and ensure the wheelchair comes to rest and the brakes are applied without the front wheels lifting of the ground.

5 SERVICING OF DEFECTIVE UNITS

Excluding the items listed in Section 1 of this Chapter there are no serviceable parts, in any of the PGDT control systems. Consequently, any defective units must be returned to PGDT or a PGDT approved service organization for repair.



Any replacement work carried out without the wheelchair manufacturer's permission will invalidate the control system's warranty.

Opening or making any unauthorized adjustments or modifications to a control system or its components will invalidate any warranty and may result in hazards to the vehicle user, and is strictly forbidden.



Penny & Giles Controls Limited accepts no liability for losses of any kind arising from unauthorized opening, adjustments or modifications to a any component of a control system.



CHAPTER 8 – WARNING SUMMARY

1 INTRODUCTION

This section summarizes all of the very important warnings that appear throughout the text of this manual. Do not install, maintain or operate the VR2 control system without reading, understanding and observing the following warnings. Failure to observe these warnings could result in UNSAFE CONDITIONS for the user of a wheelchair or affect the reliability of the control system. PG Drives Technology accepts no liability for losses of any kind arising from failure to comply with any of the conditions in the warnings listed below. Failure to observe these warnings will invalidate the VR2 warranty.

The wheelchair manufacturer may wish to use this section as a check list, to ensure the risk areas identified below have been addressed within their own wheelchair designs and associated documentation.

2 WARNINGS

2.1 DRIVING TECHNIQUE



The wheelchair user must be capable of driving a wheelchair safely. Penny & Giles Controls Limited accepts no liability for losses of any kind arising from failure to comply with this condition. Chapter 1 section 5.2.

2.2 HAZARDS



Although the VR2 control system is designed to be extremely reliable and each unit is rigorously tested during manufacture, the possibility of a system malfunction always exists (however small the probability). Under some conditions of system malfunction the control system must (for safety reasons) stop the chair instantaneously. If there is any possibility of the user falling out of the chair as a result of a sudden braking action, it is imperative that a restraining device such as a seat belt is supplied with the wheelchair and that it is in use at all times when the wheelchair is in motion. Penny & Giles Controls Limited accepts no liability for losses of any kind arising from the unexpected stopping of the wheelchair, or from the improper use of the wheelchair or control system.



Do not operate the control system if the chair behaves erratically, or shows abnormal signs of heating, sparks or smoke. Turn the control system off at once and consult your service agent. Penny & Giles Controls Limited accepts no liability for losses of any kind arising from failure to comply with this condition.



Electronic equipment can be affected by Electro Magnetic Interference (EMI). Such interference may be generated by radio stations, TV stations, other radio transmitters and cellular phones. If the chair exhibits erratic behavior due to EMI, turn the control system off immediately and consult your service agent. Penny & Giles Controls Limited accepts no liability for losses of any kind arising from failure to comply with this condition.



It is the responsibility of the chair manufacturer to ensure that the wheelchair complies with appropriate National and International EMC legislation. Penny & Giles Controls Limited accepts no liability for losses of any kind arising from failure to comply with this condition.



The wheelchair user must comply with all wheelchair safety warnings. Penny & Giles Controls Limited accepts no liability for losses of any kind arising from failure to comply with this condition. Chapter 1 section 6.1.

2.3 HOW TO READ A TRUCHARGE BATTERY GAUGE



Do not operate the control system if the battery is nearly discharged. Failure to comply with this condition may leave the user stranded in an unsafe position, such as in the middle of a road. Penny & Giles Controls Limited accepts no liability for losses of any kind arising from failure to comply with this condition. Chapter 1 section 9.1.

2.4 BATTERY CHARGING



Do not exceed the maximum charging current. For D51427 the maximum charging current is 6Arms, for all other VR2 JSMs it is 12 Arms. Always use an off-board charger fitted with a Neutrik NC3MX plug. Failure to observe these conditions could result in poor contact resistance in the charger connector resulting in overheating of the charger plugs. This presents a potential burn hazard for the user. Penny & Giles Controls Limited accepts no liability for losses of any kind arising from failure to comply with this condition.



Ensure that the charger plug pins are of the correct polarity with that shown on the specific control system's data sheet. Failure to observe this condition could result in a burn hazard or fire hazard. Penny & Giles Controls Limited accepts no liability for losses of any kind arising from failure to comply with this condition.



Do not disconnect batteries or open-circuit the circuit breaker while charging is in progress. Failure to observe this condition could result in a burns hazard or fire hazard. Penny & Giles Controls Limited accepts no liability for losses of any kind arising from failure to comply with this condition.



Only use the battery charger that has been supplied with your wheelchair. The use of incorrect chargers could damage the batteries, wheelchair, control system or charger itself, or may result in parts overheating creating the potential for burns or even fire. Penny & Giles Controls Limited accepts no liability for losses of any kind if the charger is incompatible with the control system (see Chapter 2, section 8) or any other part of the wheelchair system. Chapter 1 section 10.

2.5 PROGRAMMING



Programming should only be conducted by healthcare professionals with in-depth knowledge of Penny & Giles Controls Limited electronic control systems. Incorrect programming could result in an unsafe set-up of a wheelchair. Penny & Giles Controls Limited accept no liability for losses of any kind if the programming of the control system is altered from factory pre-set values. Chapter 1 section 11.



2.6 JOYSTICK KNOBS



Do not replace the joystick knob with any unauthorized item – it may cause hazardous operation. Penny & Giles Controls Limited accepts no liability for losses. Chapter 1 section 12.

2.7 SERVICING



Penny & Giles Controls Limited accepts no liability for losses of any kind arising from unauthorized opening, adjustment or modifications to the VR2 control system.



If the control system is damaged in any way, or if internal damage may have occurred through impact or dropping, have the product checked by qualified personnel before operating. Penny & Giles Controls Limited accepts no liability for losses of any kind arising from failure to comply with this condition. Chapter 1 section 13.

2.8 WARRANTY



The warranty will be void if the VR2 has not been used in accordance with VR2 Technical Manual SK77898, the VR2 has been subject to misuse or abuse, or if the VR2 has been modified or repaired by unauthorized persons. Chapter 1 section 14.

2.9 PROGRAM SETTINGS



It is the manufacturers responsibility to program the control system to suit the vehicle model and ensure safe operation in compliance with relevant legal requirements over the whole of the operating range. Penny & Giles Controls Limited accepts no liability for losses of any kind due incorrect programming or the VR2 Control System. Refer to Chapter 3 for programming details.



Programming should only be conducted by healthcare professionals with in-depth knowledge of Penny & Giles Controls Limited electronic control systems. Incorrect programming could result in an unsafe set-up of a wheelchair for the user. Penny & Giles Controls Limited accepts no liability for losses of any kind if the programming of the control system is altered from factory pre-set values. Penny & Giles Controls Limited accepts no liability for losses of any kind if the drive or stability characteristics of the chair are altered without prior notification and discussion with Penny & Giles Controls Limited. Chapter 2 section 1.2.

2.10 CHARGER INTERLOCK



The chair manufacturer is responsible for providing a means of preventing the use of the wheelchair while the batteries are being charged. Penny & Giles Controls Limited accepts no liability for losses of any kind arising from failure to comply with this condition. Chapter 2 section 2.2.

2.11 POSITION



It is possible for the case temperature of the Power Module to rise above 41°C (107°F). For this reason the Lighting Module should be fixed in a position where it cannot be touched by the wheelchair user. Chapter 2 section 3.2.2.

2.12 CRIMPING



Defective or poor quality crimps may affect the warranty of the controller. Penny & Giles Controls Limited accepts no liability for losses of any kind arising from failure to comply with this condition. Chapter 2 section 4.1.

2.13 WIRING – GENERAL



The chair manufacturer is responsible for establishing the suitability of the particular wiring arrangements used on the wheelchair, for both normal use and stalled conditions. Penny & Giles Controls Limited can make general recommendations for wiring of VR2 control systems, but Penny & Giles Controls Limited accepts no responsibility or liability for losses of any kind arising from the actual wiring arrangement used.



The chair manufacturer is responsible for ensuring that only the mating connectors specified by Penny & Giles Controls Limited on the control system's specific data sheet are used to connect to the control system. Penny & Giles Controls Limited accepts no liability for losses of any kind arising from failure to comply with this condition.



The chair manufacturer is responsible for ensuring that suitable connectors are used and securely mated throughout the chair wiring system and also for the quality of the wiring system. Failure to meet this condition could result in intermittent operation, sudden stopping or veering and even create a burn or fire hazard. Penny & Giles Controls Limited accepts no liability for losses of any kind arising from failure to comply with this condition. Chapter 2 section 5.1.

2.14 BATTERY WIRING



The chair manufacturer must install a suitable circuit breaker to provide protection against short circuits in the battery wiring, power loom or the control system. Failure to comply with this could result in a fire hazard. Penny & Giles Controls Limited accepts no liability for losses of any kind arising from failure to comply with this condition. Chapter 2 section 5.3.

2.15 DRIVE MOTORS



The chair manufacturer is responsible for ensuring that the control system is matched to the motor resistance. Failure to do this may result in poor control characteristics, which in extreme instances can make a chair uncontrollable and potentially unsafe. Penny & Giles Controls Limited accepts no liability for losses of any kind arising from failure to comply with this condition.



The chair manufacturer is responsible for always ensuring that any replacement motor or gearbox is fully compatible with the original control system. Failure to do this may result in poor control characteristics, which in extreme instances can make a chair uncontrollable and potentially unsafe. Penny & Giles Controls Limited accepts no liability for losses of any kind arising from failure to comply with this condition.



Users must not transfer a control system from one chair type to install it on a different chair type. Control systems with different part numbers may have both hardware and software differences to ensure that they are compatible with the electrical and dynamic characteristics of their specific target vehicles. The characteristics of one type of control system may not be compatible with a different, unauthorized chair. Failure to observe this warning could result in an unsafe set-up for the wheelchair user and may create a fire hazard depending on the motors, wiring, connectors and circuit breakers installed on the unauthorized chair. Penny & Giles Controls Limited accepts no liability for losses of any kind arising from failure to comply with this condition. Chapter 2 section 6.

2.16 OFF-BOARD CHARGING



Do not exceed the maximum charging current of 12 Arms. Always use an off-board charger fitted with a Neutrik NC3MX plug. Failure to observe these conditions could result in poor contact resistance in the charger connector resulting in overheating of the charger plugs. This presents a potential burn hazard for the user. Penny & Giles Controls Limited accepts no liability for losses of any kind arising from failure to comply with this condition.



Ensure that the charger plug pins are of the correct polarity with that shown on the specific control system's data sheet. Failure to observe this condition could result in a burn hazard or fire hazard. Penny & Giles Controls Limited accepts no liability for losses of any kind arising from failure to comply with this condition.



Do not disconnect batteries or open-circuit the circuit breaker while charging is in progress. Failure to observe this condition could result in a burns hazard or fire hazard. Penny & Giles Controls Limited accepts no liability for losses of any kind arising from failure to comply with this condition. Chapter 2 section 8.1.

2.17 ON-BOARD CHARGING



Do not exceed the maximum charging current of 12A rms. Always use an on-board charger sited with the Inconnect parts specified in section 4.2. Penny & Giles Controls Limited accepts no liability for losses of any kind arising from failure to comply with this condition.



Ensure that the charger plug pins are of the correct polarity with that shown on the specific control system's data sheet. Failure to observe this condition could result in a burn hazard or fire hazard. Penny & Giles Controls Limited accepts no liability for losses of any kind arising from failure to comply with this condition.



Do not disconnect batteries or open-circuit the circuit breaker while charging is in progress. Failure to observe this condition could result in a burns hazard or fire hazard. Penny & Giles Controls Limited accepts no liability for losses of any kind arising from failure to comply with this condition. Chapter 2 section 8.2.

2.18 PRODUCTION TEST



These tests should be conducted in an open space and a restraining device such as a seat belt should always be used. Penny & Giles Controls Limited accepts no liability for losses of any kind arising from failure to comply with this condition. Chapter 2 section 11.

2.19 MOUNTING



The chair manufacturer is responsible for ensuring that only the mating connectors specified by Penny & Giles Controls Limited on the control systems' specific data sheet are used to connect to the control system. Penny & Giles Controls Limited accepts no liability for losses of any kind arising from failure to comply with this condition.



The chair manufacturer is responsible for ensuring that suitable connectors are used and securely mated throughout the chair wiring system and that the workmanship associated with the wiring system is of a good enough quality. Failure to meet this condition could result in intermittent operation, sudden stopping or veering, or even create a burn or fire hazard. Penny & Giles Controls Limited accepts no liability for losses of any kind arising from failure to comply with this condition. Chapter 3 section 4.1.

2.20 WIRE GAUGES



The chair manufacturer is responsible for establishing the suitability of the particular wiring arrangements used on the wheelchair, for both normal use and stalled conditions. Penny & Giles Controls Limited can make general recommendations for wiring for control systems, but Penny & Giles Controls Limited accepts no responsibility for, and accepts no liability for losses of any kind arising from, the actual wiring arrangement used. Chapter 3 section 4.3.

2.21 BATTERY WIRING



The chair manufacturer must install a suitable circuit breaker to provide protection against short circuits in the battery wiring, power loom or the control system. Failure to comply with this could result in a fire hazard. Penny & Giles Controls Limited accepts no liability for losses of any kind arising from failure to comply with this condition. Chapter 3 section 4.4.

2.22 BATTERY CHARGING



Do not exceed the maximum charging current of 6Arms. Always use an off-board charger fitted with a Neutrik NC3MX plug. Failure to observe these conditions could result in poor contact resistance in the charger connector resulting in overheating of the charger plugs. This presents a potential burn hazard for the user. Penny & Giles Controls Limited accepts no liability for losses of any kind arising from failure to comply with this condition.



Ensure that the charger plug pins are of the correct polarity to be compatible with the pin polarity shown on the control system's specific data sheet. Failure to observe this condition could result in a burn hazard or fire hazard. Penny & Giles Controls Limited accepts no liability for losses of any kind arising from failure to comply with this condition.



Do not disconnect batteries or open-circuit the circuit breaker while charging is in progress. Failure to observe this condition could result in a burns hazard or fire hazard. Penny & Giles Controls Limited accepts no liability for losses of any kind arising from failure to comply with this condition. Chapter 3 section 4.6.

2.23 PROGRAMMING – INTRODUCTION



Programming should only be conducted by healthcare professionals with in-depth knowledge of Penny & Giles Controls Limited control systems. Incorrect programming could result in an unsafe set-up of a wheelchair for a user. Penny & Giles Controls Limited accepts no responsibility for losses of any kind if the programming of the control system is altered from the factory pre-set values. Chapter 4 section 1.

2.24 SAFETY FENCES



Penny & Giles Controls Limited accepts no liability for losses of any kind if the chair manufacturer does not specify appropriate safety fence values for a particular wheelchair application. Chapter 4 section 1.4.

2.25 BRAKE FAULT DETECT



This parameter should only ever be set to off if there are no electrical brakes fitted to the wheelchair. Chapter 5 section 7.9.

2.26 CURRENT LIMITS



The values in the table, VR2 Current Management, should never be exceeded. Doing so will invalidate the warranty and affect the long term reliability of the control system. Chapter 4 section 8.1.

2.27 MOTOR COMPENSATION



Never exceed the 70% relationship described above.



The chair manufacturer is responsible for ensuring that the control system is matched to the motor resistance. Failure to do this may result in poor control characteristics, which in extreme instances can make a chair uncontrollable and potentially unsafe. Penny & Giles Controls Limited accepts no liability for losses of any kind arising from failure to comply with this condition.



The chair manufacturer is responsible for always ensuring that any replacement motors or gearboxes are fully compatible with the originals that the control system was designed to match. Failure to do this may result in poor control characteristics, which in extreme instances can make a chair uncontrollable and potentially unsafe. Penny & Giles Controls Limited accepts no liability for losses of any kind arising from failure to comply with this condition.



Users must not move a control system from one chair type to install it on a different chair type. Control systems with different part numbers may have both hardware and software differences to ensure that they are compatible with the electrical and dynamic characteristics of their specific target vehicles. The characteristics of one type of control system may not be compatible with a different, unauthorized chair. Failure to observe this warning could result in an unsafe set-up for the wheelchair user and may create a fire hazard depending on the motors, wiring, connectors and circuit breakers installed on the unauthorized chair. Penny & Giles Controls Limited accepts no liability for losses of any kind arising from failure to comply with this condition. Chapter 4 section 8.2.

2.28 TORQUE



Ensure that the motor compensation is set correctly for the chair, torque does not counter the effects of incorrect compensation settings. Chapter 4 section 8.6.

2.29 TREMOR DAMPING



The higher Tremor Damping is set the slower joystick response will become.



When setting Tremor Damping, pay particular attention to stopping distances. As the parameter dampens the response to the joystick commands, stopping distance can be affected. To stop the wheelchair with Tremor Damping activated you must release the joystick and allow it to center. It is the responsibility of the wheelchair manufacturer to ensure requirements on stopping distances are adhered to. Chapter 4 section 8.7.

2.30 MOUNTING



It is possible for the case temperature of the Lighting Module to rise above 41°C (107°F). For this reason the Lighting Module should be fixed in a position where it cannot be touched by the wheelchair user. Chapter 5 section 3.1.

2.31 WIRING



For lighting module sockets 1 and 2 only use the exact parts specified below for the mating connector.



Penny & Giles Controls Limited accepts no liability for losses of any kind arising from damage to or failure of the wheelchair lighting system, including any associated wiring. It is the responsibility of the wheelchair manufacturer to ensure that the lighting system wiring complies with all relevant standards. Chapter 6 section 3.4.

2.32 SERVICING - INTRODUCTION



Any replacement work carried out without the wheelchair manufacturer's permission will invalidate the control system's warranty. Penny & Giles Controls Limited accepts no liability for losses of any kind if the procedure and safety guidelines are not followed. These operations should only be carried out by a trained Healthcare Technician. Chapter 7 section 1.1.

2.33 DIAGNOSTICS - INTRODUCTION



Diagnostics should only be conducted by healthcare professionals with in-depth knowledge of Penny & Giles Controls Limited electronic controllers. An incorrect or badly effected repair could result in an unsafe set-up of a wheelchair. Penny & Giles Controls Limited accept no liability for losses of any kind arising from an incorrect or badly effected repair. Chapter 7 section 2.1.

2.34 BATTERIES DISCHARGE VERY QUICKLY



The ambient temperature has a significant effect on battery capacity. Therefore, if the temperature is lower than normal the wheelchair's range will be reduced. In this situation, the TruCharge battery gauge still gives an accurate state-of-charge reading. Chapter 7 section 2.4.5.

2.35 BASIC TESTS



These tests are a minimum recommendation only. It is the responsibility of the service person(s) to perform other tests relevant to the original trip and wheelchair type are carried out. Refer to the wheelchair's Technical Manual for exact information of other tests. Penny & Giles Controls Limited accepts no liability for losses of any kind arising from the carrying out of the described tests, or from not carrying out additional relevant tests.



These tests should be conducted in an open space and a restraining device such as a seat belt should always be used. Penny & Giles Controls Limited accepts no liability for losses of any kind arising from failure to comply with this condition. Chapter 7 section 4.

2.36 GRADIENT TEST



Before carrying out this test ensure another person is present to prevent the wheelchair from tipping backwards. Chapter 7 section 4.4.

2.36 SERVICING OF DEFECTIVE UNITS



Any replacement work carried out without the wheelchair manufacturer's permission will invalidate the control system's warranty.



Penny & Giles Controls Limited accepts no liability for losses of any kind arising from unauthorized opening, adjustments or modifications to a any component of a control system. Chapter 7 section 5.





CHAPTER 9 – SPECIFICATIONS

1 ELECTRICAL SPECIFICATIONS

1.1 VR2 50, 60, 70 & 90

Supply Voltage:	24Vdc
Operating Voltage:	16Vdc to 35Vdc
Peak Voltage:	35Vdc
Reverse Battery Voltage:	40Vdc
PWM Frequency:	20kHz \pm 0.5%
Brake Voltage:	12Vdc or 24Vdc
Brake Current:	100mA min. 1A max.
Charger Connector:	Use only Neutrik NC3MX
Batt. Charging Current:	12A max.
Actuator Current:	12A max.
Maximum Drive Current:	
VR2 60	60A
VR2 70	70A
VR2 90	90A
Moisture Resistance:	IPx4
Operating Temperature:	-25°C to +50°C
Storage Temperature:	-40°C to +65°C



1.2 VR2 PM 50 & VR2 PM 60

Supply Voltage:	24Vdc
Operating Voltage:	16Vdc to 35Vdc
Peak Voltage:	35Vdc
Reverse Battery Voltage:	40Vdc
PWM Frequency:	20kHz \pm 0.5%
Brake Voltage:	24Vdc
Brake Current:	100mA min. 1A max.
Charger Connector:	Use only Neutrik NC3MX
Batt. Charging Current:	6A max.
Maximum Drive Current:	
VR2 PM 50	50A
VR2 PM 60	60A
Moisture Resistance:	IPx4
Operating Temperature:	-25°C to +50°C
Storage Temperature:	-40°C to +65°C

1.3 EMC TESTED ON SAMPLE WHEELCHAIR:

Susceptibility:	Tested at 30V/m to EN12184 and ANSI/ RESNA requirements
Emissions:	To EN55022 Class B
ESD:	IEC801 part 2